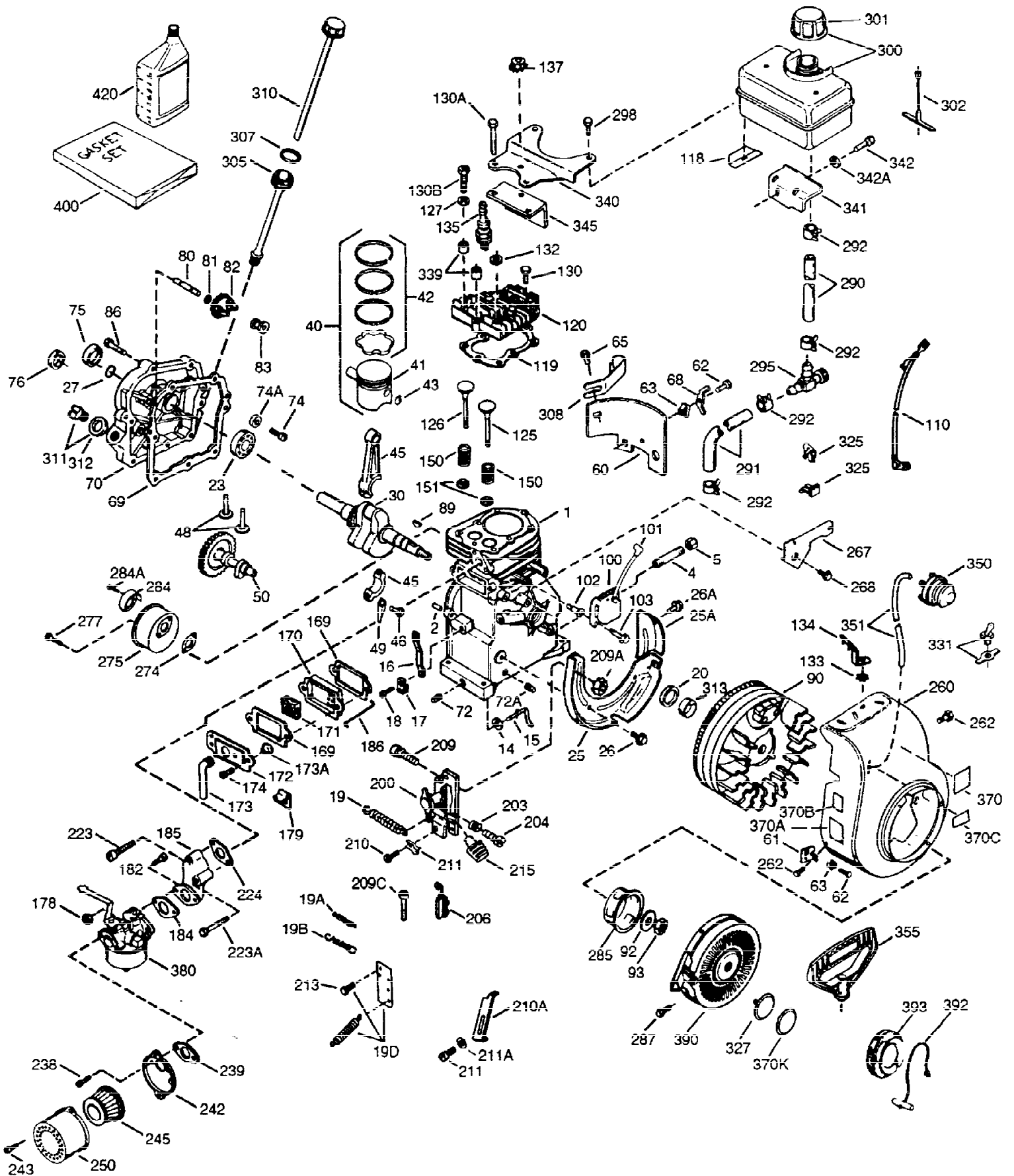

ILLUSTRATION SHOWS TYPICAL PARTS ONLY. ORDER BY PART NUMBER. PARTS NOT LISTED ARE SUPPLIED BY OEM.

VIEW 1 OF 2



Ref #	Part Number	Qty	Description
1	36589	1	Cylinder (Incl. 2,20,72 & 125)
2	26727	2	Dowel Pin
14	28277	1	Washer
15	31334	1	Governor Rod
16	31510	1	Governor Lever
17	31335	1	Governor Lever Clamp
18	650548	1	Screw, 8-32 x 5/16"
19	31426	1	Extension Spring
20	32600	1	Oil Seal
23	28458	1	Ball Bearing
25A	35883	1	Baffle Extension
25	36552	1	Blower Housing Baffle (Incl. 262)
26A	650926	1	Screw, 8-32 x 21/64"
26	650802	2	Screw, 1/4-20 x 5/8"
27	28539	1	Bearing Retainer
30	34723	1	Crankshaft
40	34514	1	Piston, Pin & Ring Set (Std.)
40	34515	1	Piston, Pin & Ring Set (.010" OS)
40	34516	1	Piston, Pin & Ring Set (.020" OS)
41	32538B	1	Piston & Pin Ass'y. (Std.) (Incl. 43)
41	32548B	1	Piston & Pin Ass'y. (.010" OS) (Incl. 43)
41	32549B	1	Piston & Pin Ass'y. (.020" OS) (Incl. 43)
42	28986	1	Ring Set (Std.)
42	28987	1	Ring Set (.010" OS)
42	28988	1	Ring Set (.020" OS)
43	20381	2	Piston Pin Retaining Ring
45	30963B	1	Connecting Rod Ass'y. (Incl. 46 & 49)
46	32610A	2	Connecting Rod Bolt
48	27241	2	Valve Lifter
49	28594	1	Oil Dipper
50	33149A	1	Camshaft (BCR)
60	29745	1	Blower Housing Extension
65	650128	1	Screw, 10-24 x 1/2"
69	27677A	1	* Cylinder Cover Gasket
70	30756C	1	Cylinder Cover (Incl. 75 thru 83 & 31 1)
72	27642	2	Oil Drain Plug
74A	28537	2	Washer
74	30200	2	Screw, 10-24 x 9/16"
75	28540	1	Oil Seal
80	30574A	1	Governor Shaft
81	30590A	1	Washer
82	30591	1	Governor Gear Ass'y. (Incl. 81)
83	30588A	1	Governor Spool
86	650488	7	Screw, 1/4-20 x 1-1/4"
89	610961	1	Flywheel Key
90	611195	1	Flywheel
92	650815	1	Belleville Washer
93	650816	1	Flywheel Nut
100	34443A	1	Solid State Ignition
101	610118	1	Spark Plug Cover
102	650872	2	Stud
103	651007	2	Screw, Torx T-15, 10-24 x 15/16"
110	35182	1	Ground Wire
119	36437	1	* Cylinder Head Gasket
120	36438	1	Cylinder Head (Incl. 130)

Ref #	Part Number	Qty	Description
125	36471	1	Exhaust Valve (Std.) (Incl. 151)
125	36472	1	Exhaust Valve (1/32" OS) (Incl. 151)
126	29314B	1	Intake Valve (Std.) (Incl. 151)
126	29315C	1	Intake Valve (1/32" OS) (Incl. 151)
130A	6021A	3	Screw, 5/16-18 x 1-1/2"
130	650694A	5	Screw, 5/16-18 x 2"
135	33636	1	Resistor Spark Plug (J8C)
150	31672	2	Valve Spring
151	31673	2	Valve Spring Cap
169	27234A	2	* Valve Cover Gasket
170	27666	1	Breather Body
171	31410	1	Breather Element
172	34146	1	Valve Cover
173	35350	1	Breather Tube
174	30200	2	Screw, 10-24 x 9/16"
178	29752	2	Nut & Lock Washer, 1/4-28
182	6201	2	Screw, 1/4-28 x 7/8"
184	26756	1	* Carburetor To Intake Pipe Gasket
185	28416A	1	Intake Pipe
186	31858	1	Governor Link
200	36677	1	Control Bracket (Incl.203,204,206,209 & 209A)
203	31342	1	Compression Spring
204	650549	1	Screw, 5-40 x 7/16"
206	610973	1	Terminal
209	650139	2	Screw, 8-32 x 3/4"
209A	30322	2	Lock Nut
215	32410	1	Control Knob
223	650664	1	Screw, 1/4-20 x 1-19/32"
223A	650840	1	Screw, 1/4-20 x 1-7/32"
224	26754A	1	* Intake Pipe Gasket
238	650152	2	Screw, 8-32 x 3/8"
239	27272A	1	* Air Cleaner Gasket
242	31691	1	Air Cleaner Base
243	28820	2	Screw, 10-32 x 1/2"
245	31700	1	Air Cleaner Filter
250	31715	1	Air Cleaner Cover
260	35585	1	Blower Housing
262	650737	2	Screw, 1/4-20 x 1/2"
267	34212	1	Hold Down Bracket
268	30200	1	Screw, 10-24 x 9/16"
275	36473	1	Muffler (Incl. 277)
277	650988	2	Screw, 1/4-20 x 2-5/16"
285	36467A	1	Starter Cup
287	650926	2	Screw, 8-32 x 21/64"
290	30705	1	Fuel Line
292	26460	2	Fuel Line Clamp
298	650665	2	Screw, 1/4-15 x 7/8"
300	35584	1	Fuel Tank (Incl. 292 & 301)
301	36246	1	Fuel Cap
311	27625	1	Oil Fill Plug
313	34080	1	Spacer
340	36247	1	Fuel Tank Bracket
342	650751	1	Screw, 1/4-20 x 7/16"
345	33344	1	Heat Baffle
370B	35703	1	Control Decal

Ref #	Part Number	Qty	Description
370	550223	1	Name Decal
370K	36695	1	Starter Decal
370A	36261	1	Lubrication Decal
380	631921	1	Carburetor (Incl. 184)
390	590732	1	Rewind Starter (NOTE: This engine could have been built with 590738 starter. Refer to the design of the rope pulley strength ribs for part identification. Individual starter parts do not interchange. Refer to service bulletin 116.)
400	36439	1	* Gasket Set (Incl. items marked PK in notes) Incl. part #'s 26754A (1), 26756 (1), 27234A (2), 27272A (1), 27677A (1), 29673 (1), 30081A (1), 31688A (1), 32649A (1), 36437 (1)
420	730225	1	SAE 30 4-Cycle Engine Oil (Quart)

ILLUSTRATION SHOWS TYPICAL PARTS ONLY. ORDER BY PART NUMBER. PARTS NOT LISTED ARE SUPPLIED BY OEM.

VIEW 2 OF 2

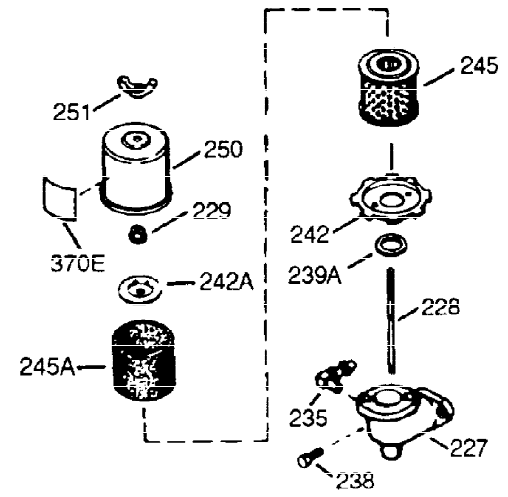
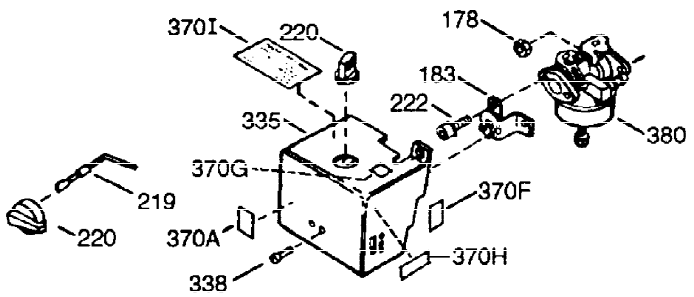
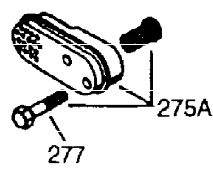
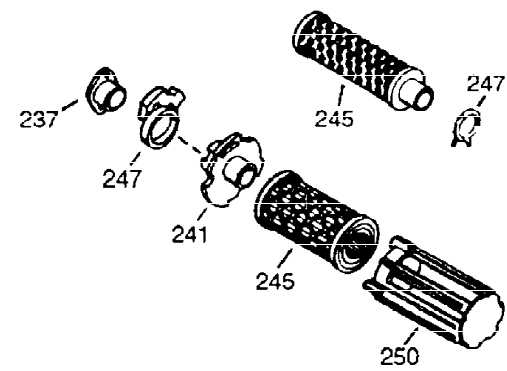
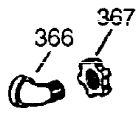
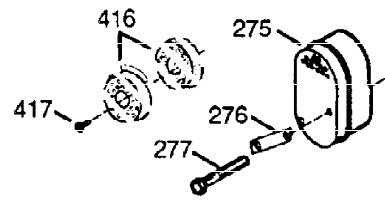
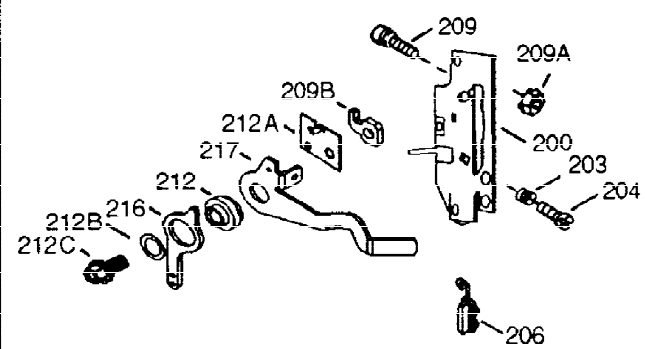
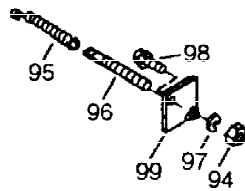
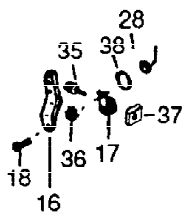

OPTIONAL 110 - 120 VOLT
STARTER MOTOR KIT

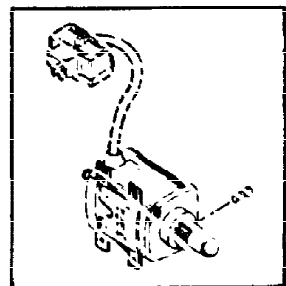

396

Ref #	Part Number	Qty	Description
16	31510	1	Governor Lever
17	31335	1	Governor Lever Clamp
18	650548	1	Screw, 8-32 x 5/16"
178	29752	2	Nut & Lock Washer, 1/4-28
200	36677	1	Control Bracket (Incl.203,204,206,209 & 209A)
203	31342	1	Compression Spring
204	650549	1	Screw, 5-40 x 7/16"
206	610973	1	Terminal
209A	30322	2	Lock Nut
209	650139	2	Screw, 8-32 x 3/4"
238	650152	2	Screw, 8-32 x 3/8"
242	31691	1	Air Cleaner Base
245	31700	1	Air Cleaner Filter
250	31715	1	Air Cleaner Cover
275	36473	1	Muffler (Incl. 277)
277	650988	2	Screw, 1/4-20 x 2-5/16"
370A	36261	1	Lubrication Decal
380	631921	1	Carburetor (Incl. 184)