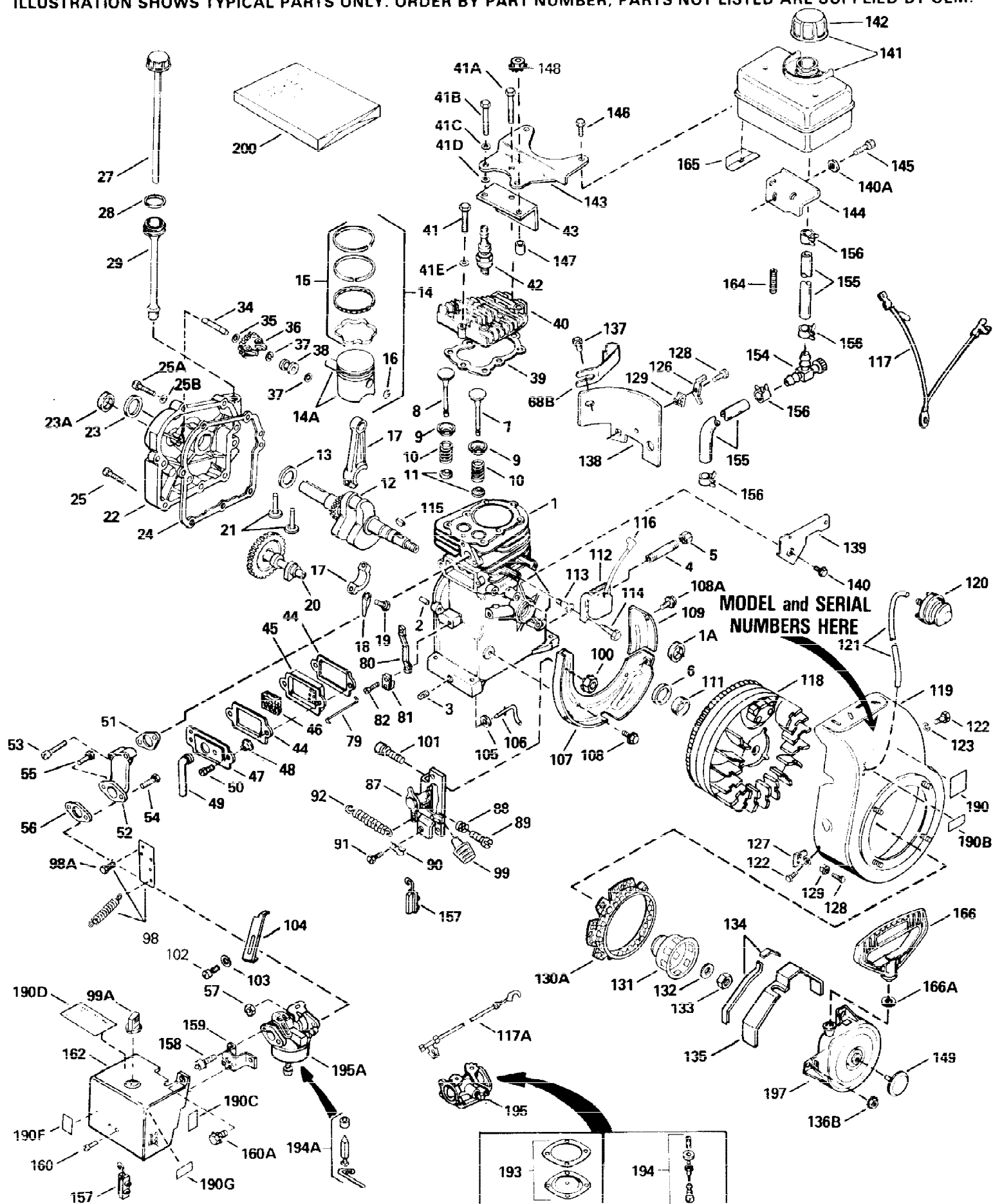

ILLUSTRATION SHOWS TYPICAL PARTS ONLY. ORDER BY PART NUMBER, PARTS NOT LISTED ARE SUPPLIED BY OEM.



Ref #	Part Number	Qty	Description
1	34755A		Cylinder (Incl. 2, 3 & 6) (2-1/2" Bore)
2	26727		Pin, Dowel
3	27642		Pipe plug, 1/4-18
6	32600		Seal, Oil
7	29314B		Intake Valve (Std.) (Incl. 11)
7	29315C		Intake Valve (1/32" OS) (Incl. 11)
8	29313C		Exhaust Valve (Std.) (Incl. 11)
8	29315C		Exhaust Valve (1/32" OS) (Incl. 11)
9	31671		Valve Spring Cap (Used in early production)
10	31672		Spring, Valve
11	31673		Valve Spring Cap
12	34734A		Crankshaft
13	32323		Washer, Thrust
14A	32538B		Piston & Pin Ass'y.(Std.)(2-1/2")(Incl.16)
14A	32548B		Piston & Pin Ass'y. (.010" OS) (Incl. 16)
14A	32549B		Piston & Pin Ass'y. (.020" OS) (Incl. 16)
14	34514		Piston, Pin & Ring Set (Std.) (2-1/2" Bore)
14	34515		Piston, Pin & Ring Set (.010" OS)
14	34516		Piston, Pin & Ring Set (.020" OS)
15	28986		Ring Set (Std.) (2-1/2" Bore)
15	28987		Ring Set (.010" OS)
15	28988		Ring Set (.020" OS)
16	20381		Ring, Piston retaining
17	32875		Rod Assy., Connecting (Incl. 18 & 19)
18	32654		Dipper, Oil
19	32610A		Bolt, Connecting rod
20	33149A		Camshaft
21	27241		Lifter, Valve
22	32700A		Cover, Cylinder (Incl. 23, 25, 26, 28 & 34)
23	27897		Seal, Oil
24	27677A		* Gasket, Cylinder cover
25	650488		Screw, 1/4-20 x 1-1/4"
28	29673		* Gasket, Oil fill plug
34	30574		Shaft, Mechanical governor
35	35479		Washer, Flat
36	30591		Gear Assy., Governor (Incl. 35)
37	29193		Ring, Retaining
38	30588A		Spool, Governor
39	29953C		* Gasket, Cylinder head
40	30579A		Head, Cylinder (Incl. 41A)
41A	650694A		Screw, 5/16-18 x 2" (Use as required)
41	650695A		Screw, 5/16-18 x 2-1/4" (Use as required)
41	6021A		Screw, 5/16-18 x 1-1/2" (Use as required)
41	650865		Screw, 5/16-18 x 2" (Use as required)
42	33636		Resistor Spark Plug (J-8C)
43	33344		Baffle, Heat
44	31619A		* Gasket, Breather (One required)
45	31337		Breather Assy. (Incl. 44 & 46)
46	31410		Element, Breather
50	650128		Screw, 10-24 x 1/2"
51	26754A		* Gasket, Intake to cylinder
52	28416A		Pipe, Intake (Incl. 54)
53	650664		Screw, 1/4-20 x 1-19/32"
54	650840		Screw, 1/4-20 x 1-7/32"
55	6201		Screw, 1/4-28 x 7/8"

Ref #	Part Number	Qty	Description
56	26756		* Gasket, Carburetor to intake
57	29752		Nut & Lockwasher Assy., 1/4-28
79	31858		Link, Throttle
80	31510		Lever, Governor
81	29916		Clamp, Governor lever
82	650548		Screw, 8-32 x 5/16"
87	730136A		Control Bkt.(Incl.88,89,90,91,92,98,1 00,101) NOTE: In original production the speed control assembly is riveted to the blower housing baffle (Ref. #107). Replacement speed control assembly includes screws (Ref. #101)and nuts (Ref. #100) for mounting.
88	31342		Spring, Compression
89	650549		Screw, 5-40 x 7/16"
90	27793		Clip, Conduit
91	28942		Screw, 10-32 x 3/8"
92	31426		Spring, Extension
98	33857		Spring Assy., Extension (Incl. 98A)
98A	28942		Screw, 10-32 x 3/8"
100	30322		Locknut, 8-32 (Use as required)
101	650139		Screw, 8-32 x 1/2" (Use as required)
101	650152		Screw, 8-32 x 3/8" (Use as required)
101	30200		Screw, 10-24 x 9/16" (Use as required )
105	28277		Washer, Flat
106	31334		Rod, Governor
107	33342		Baffle, Blower housing
108A	650701		Screw, 8-18 x 7/16"
108	650561		Screw, 1/4-20 x 5/8"
109	33341		Baffle, Extension
111	34080		Spacer, Flywheel key
112	34443A		Solid State Ass'y.
113	650872		Stud, Solid State mounting
114	650814		Screw, Torx T-15, 10-24 x 1"
115	610961		Flywheel key
116	610118		Cover, Spark plug (Use as required)
116	27276		Cover, Spark plug
117	35349		Ground Wire Ass'y.
118	611080		Flywheel
119	33663C		Housing, Blower NOTE: In original production, the starter may be riveted to theblower housing. If the starter or blower housing needs replacement, the other may need holes used for pop rivetingenlarged to use standard mounting hardware. Order 4 nuts (#29752) required to mount starter to replaceme
122	29212		Screw, 1/4-28 x 7/16"
123	650168		Washer
126	33356		Terminal, Ground
128	650760		Screw, 8-32 x 3/8"
129	28545		Grommet
131	34694		Cup, Starter
132	650815		Washer, Belleville
133	650816		Nut, Flywheel
136B	29752		Nut & Lockwasher Assy., 1/4-28
137	650128		Screw, 10-24 x 1/2"

Ref #	Part Number	Qty	Description
138	29745		Extension, Blower housing
139	34212		Bracket, Hold down
140	30200		Screw, 10-24 x 9/16"
141	34711		Fuel Tank (Incl. 142 & 156)
142	33032		Cap, Fuel filler (Use as required)
142	410144B		Cap, Fuel filler (Std.) (Use as required)
143	28371B		Fuel Tank Bracket
144	34182		Fuel Tank Bracket
145	650561		Screw, 1/4-20 x 5/8"
146	650665		Screw, 1/4-15 x 7/8"
147	28212		Spacer, Tank bracket (Not used in all models)
155	29774		Fuel Line (Braided, 8-1/4") (Use as required)
155	30705		Fuel Line (Braided, 16") (Use as required)
156	26460		Clamp, Fuel line (Use as required)
157	610973		Terminal Ass'y. (Use as required)
190	550223		Decal, Name
190C	34346		Decal, Instruction
194A	631021		Inlet Needle Seat & Clip Assy.
195A	631820		Carburetor (Incl. 56 & 79) (Refer to Division 5, Section A, page 206 for breakdown)
197	590420		Starter, Rewind In original production, the starter may be riveted to the blowerhousing. If the starter or blower housing needs replacement, the other may need holes used for pop riveting enlarged to use standard mounting hardware. Order 4 nuts (29752) required to mount starter to replacement blower
200	33233A		* Gasket Set (Incl. items marked *)

ILLUSTRATION SHOWS TYPICAL PARTS ONLY. ORDER BY PART NUMBER. PARTS NOT LISTED ARE SUPPLIED BY OEM.

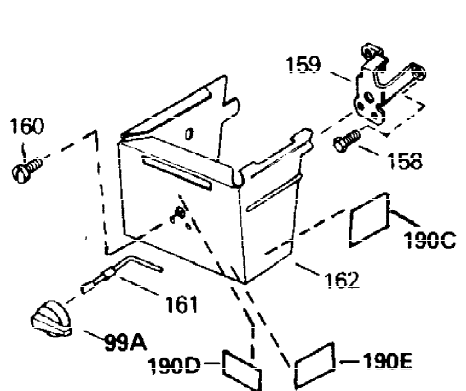
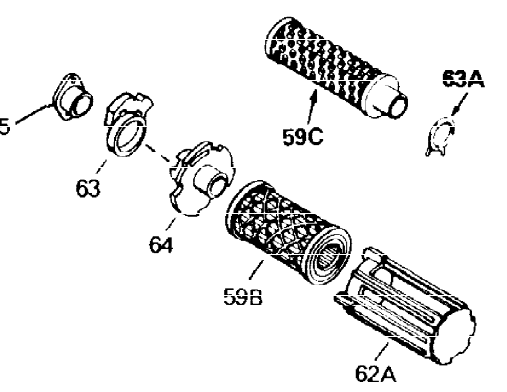
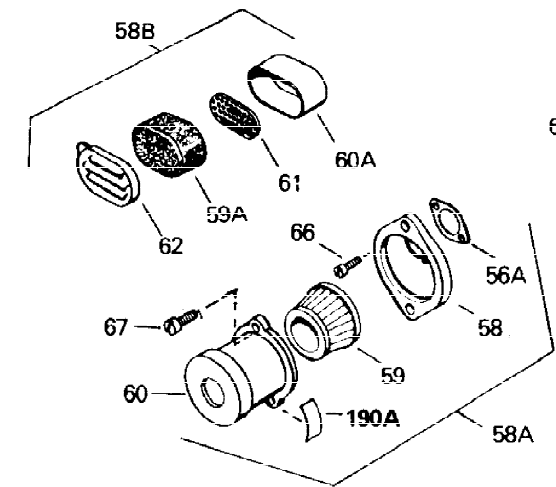
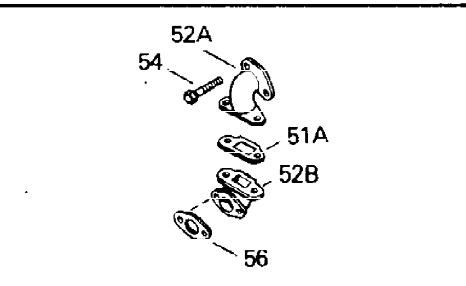
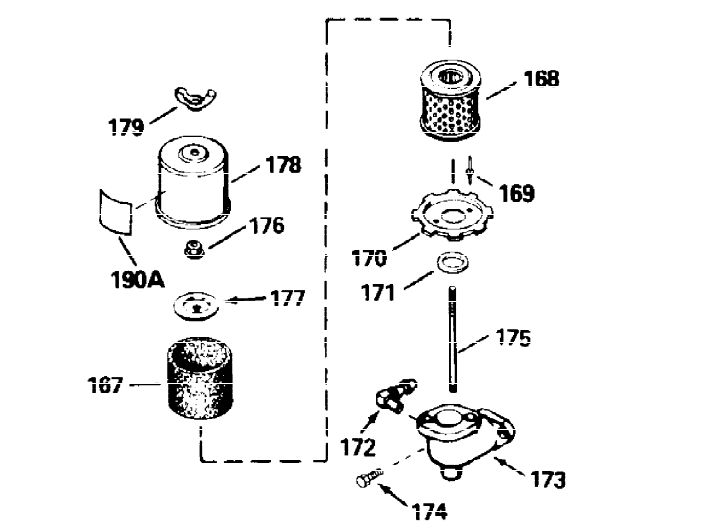
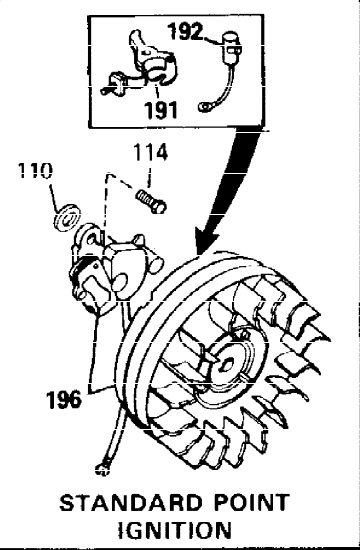
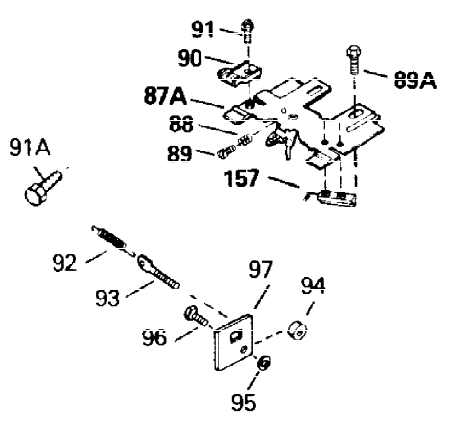
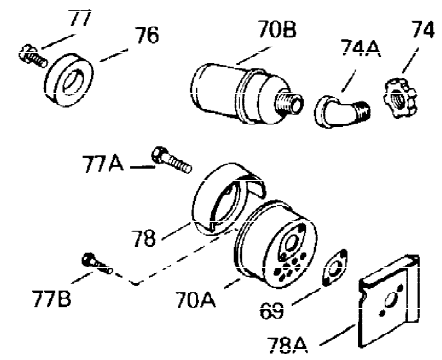
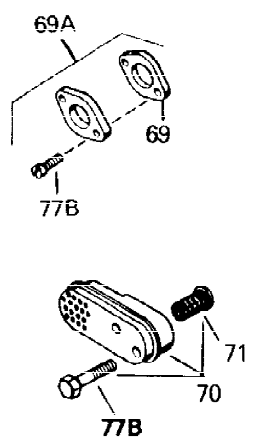
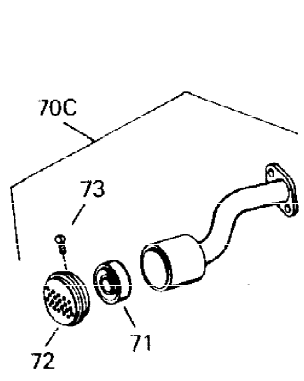
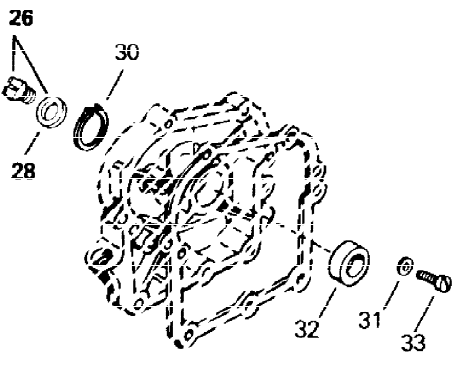
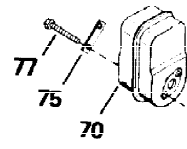
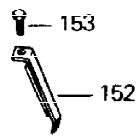
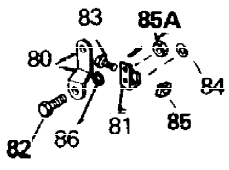

Ref #	Part Number	Qty	Description
1	34755A		Cylinder (Incl. 2, 3 & 6) (2-1/2" Bore)
26	27625		Plug, Oil fill (Incl. 28)
28	29673		* Gasket, Oil fill plug
54	650840		Screw, 1/4-20 x 1-7/32"
56A	27272A		* Gasket, Carburetor to air cleaner
56	26756		* Gasket, Carburetor to intake
58A	730127		Air Cleaner Ass'y. (Incl.56A, 58, 59, 60, 66, 67 & 170) (Use as required)
58A	730164		Air Cleaner Ass'y. (Incl. 56A, 58, 59, 60, 66, 67 & 170A) (Use as required)
58	31691		Bracket, Air cleaner
58B	31545		Air Cleaner Ass'y. (Incl. 56A, 59A, 60A, 61 & 62) (Use as required)
59	30727		Element, Air cleaner
60	31715		Body, Air cleaner
66	28820		Screw, 10-32 x 1/2"
67	650152		Screw, 8-32 x 3/8"
69	33170A		* Gasket, Muffler
69A	730162		Kit, Exhaust adapter (Incl. 69 & 77B) (Use as required) (Not for use on PTO side exhaust)
70C	33126A		Muffler (Spark Arr.) (Incl.69,71,72,73 & 77B)
71	33171		Screen, Muffler
72	33172		Cover, Muffler
73	650578		Screw, 8-18 x 3/8"
77B	650561		Screw, 1/4-20 x 5/8"
80	31510		Lever, Governor
81	29916		Clamp, Governor lever
82	650548		Screw, 8-32 x 5/16"
83	29826		Screw, 10-32 x 3/4"
84	29642		Ring, Retaining
85A	30322		Locknut, 8-32
85	29216		Locknut, 10-32
86	29918		Washer, Lock, #8 E.T.
88	31342		Spring, Compression
89	650549		Screw, 5-40 x 7/16"
90	27793		Clip, Conduit
91	28942		Screw, 10-32 x 3/8"
92	31426		Spring, Extension
114	650814		Screw, Torx T-15, 10-24 x 1"
157	610973		Terminal Ass'y. (Use as required)
161	34594		Rod, Choke
190C	34346		Decal, Instruction

ILLUSTRATION SHOWS TYPICAL PARTS ONLY. ORDER BY PART NUMBER. PARTS NOT LISTED ARE SUPPLIED BY OEM.



**MODEL and SERIAL  
 NUMBERS HERE**



**OPTIONAL 110 - 120 VOLT  
 STARTER MOTOR KIT**



**STARTER MUFF KIT  
 (OPTIONAL)**



Ref #	Part Number	Qty	Description
1	34755A		Cylinder (Incl. 2, 3 & 6) (2-1/2" Bore)
41	650695A		Screw, 5/16-18 x 2-1/4" (Use as required)
41	6021A		Screw, 5/16-18 x 1-1/2" (Use as required)
41	650865		Screw, 5/16-18 x 2" (Use as required)
68A	34246		Clip, Ground wire
111	34080		Spacer, Flywheel key
112	34443A		Solid State Ass'y.
113	650872		Stud, Solid State mounting
114	650814		Screw, Torx T-15, 10-24 x 1"
116	610118		Cover, Spark plug (Use as required)
116	27276		Cover, Spark plug
118	611080		Flywheel
119	33663C		Housing, Blower NOTE: In original production, the starter may be riveted to the blower housing. If the starter or blower housing needs replacement, the other may need holes used for pop riveting enlarged to use standard mounting hardware. Order 4 nuts (#29752) required to mount starter to replacement
122	29212		Screw, 1/4-28 x 7/16"
123	650168		Washer
124	650890		Lockwasher, 5/16
125	30747		Clip, Spark plug shorting
130	35185		Screen, Starter
163C	34870		Decal, Instruction (Optional)
163B	32204		Bracket, Starter air cleaner (Optional)
163	730571		Str.Muff Kit(Incl.163A,163B,163C)(Opt.)
163A	32203		Air Cleaner, Starter (Optional)
190	550223		Decal, Name
197	590420		Starter, Rewind In original production, the starter may be riveted to the blower housing. If the starter or blower housing needs replacement, the other may need holes used for pop riveting enlarged to use standard mounting hardware. Order 4 nuts (29752) required to mount starter to replacement blower
198A	33290D		Electric Starter Motor (120 volt) This 120-Volt starter motor kit can be used on those models equipped with electric starter provisions. Refer to Division 5, Section D, Page 16 for breakdown.