

| Ref # | Part Number | Qty | Description |
|-------|-------------|-----|---|
| 1 | 35123A | 1 | Cylinder (Incl. 2, 20 & 72) |
| 2 | 27652 | 2 | Dowel Pin |
| 15A | 30700 | 1 | Governor Yoke |
| 15 | 30699C | 1 | Governor Rod (Incl. 15A & 15B) |
| 15B | 650494 | 1 | Screw, 6-40 x 5/16" |
| 16 | 33454 | 1 | Governor Lever |
| 17 | 29916 | 1 | Governor Lever Clamp |
| 18 | 650548 | 1 | Screw, 8-32 x 5/16" |
| 19 | 34663 | 1 | Speed Control Spring |
| 20 | 32630 | 1 | Oil Seal |
| 25 | 29536 | 1 | Blower Housing Baffle |
| 26 | 650561 | 2 | Screw, 1/4-20 x 5/8" |
| 28 | 30322 | 1 | Lock Nut, 8-32 |
| 30 | 35223 | 1 | Crankshaft |
| 35 | 29826 | 1 | Screw, 10-32 x 3/4" |
| 36 | 29918 | 1 | Lock Washer |
| 37 | 29216 | 1 | Lock Nut, 10-32 |
| 38 | 29642 | 1 | Retaining Ring |
| 40 | 34531 | 1 | Piston, Pin & Ring Set (Std.) |
| 40 | 34532 | 1 | Piston, Pin & Ring Set (.010" OS) |
| 40 | 34533 | 1 | Piston, Pin & Ring Set (.020" OS) |
| 41 | 33312B | 1 | Piston & Pin Ass'y. (Std.) (Incl. 43) |
| 41 | 33313B | 1 | Piston & Pin Ass'y. (.010" OS) (Incl. 43) |
| 41 | 33314B | 1 | Piston & Pin Ass'y. (.020" OS) (Incl. 43) |
| 42 | 34854 | 1 | Ring Set (Std.) |
| 42 | 34855 | 1 | Ring Set (.010" OS) |
| 42 | 34856 | 1 | Ring Set (.020" OS) |
| 43 | 27888 | 2 | Piston Pin Retaining Ring |
| 45 | 31380C | 1 | Connecting Rod Ass'y. (Incl. 46) |
| 46 | 650662C | 2 | Connecting Rod Bolt |
| 48 | 34034 | 2 | Valve Lifter |
| 50 | 33156 | 1 | Camshaft (BCR) |
| 60 | 30622A | 1 | Blower Housing Extension |
| 65 | 650128 | 1 | Screw, 10-24 x 1/2" |
| 69 | 30684 | 1 | * Cylinder Cover Gasket |
| 70 | 31451A | 1 | Cylinder Cover (Incl. 75 & 80) |
| 72 | 27642 | 2 | Oil Drain Plug |
| 75 | 28460 | 1 | Oil Seal |
| 80 | 31845 | 1 | Governor Shaft |
| 81 | 30590A | 1 | Washer |
| 82 | 30591 | 1 | Governor Gear Ass'y. (Incl. 81) |
| 83 | 30588A | 1 | Governor Spool |
| 84 | 29193 | 1 | Retaining Ring |
| 86 | 650488 | 7 | Screw, 1/4-20 x 1-1/4" |
| 87 | 650493 | 1 | Screw, 1/4-20 x 1-3/4" |
| 89 | 32589 | 1 | Flywheel Key |
| 90 | 611084 | 1 | Flywheel |
| 92 | 650815 | 1 | Belleville Washer |
| 93 | 8116 | 1 | Flywheel Nut |
| 100 | 34443A | 1 | Solid State Ignition |
| 101 | 610118 | 1 | Spark Plug Cover |
| 102 | 650872 | 2 | Solid State Mounting Stud |
| 103 | 651007 | 2 | Screw, Torx T-15, 10-24 x 15/16" |
| 110 | 35187 | 1 | Ground Wire |
| 119 | 36445 | 1 | * Cylinder Head Gasket |

| Ref # | Part Number | Qty | Description |
|-------|-------------|-----|---------------------------------------|
| 120 | 36446 | 1 | Cylinder Head (Incl. 3 of 131) |
| 125 | 27878A | 1 | Exhaust Valve (Std.) (Incl. 151) |
| 125 | 27880A | 1 | Exhaust Valve (1/32" OS) (Incl. 151) |
| 126 | 32783 | 1 | Intake Valve (Std.) (Incl. 151) |
| 126 | 32784 | 1 | Intake Valve (1/32" OS) (Incl. 151) |
| 127 | 650691 | 3 | Washer |
| 128 | 650690 | 3 | Belleville Washer |
| 130 | 650697A | 8 | Screw, 5/16-18 x 2-1/2" |
| 135 | 33636 | 1 | Resistor Spark Plug (RJ17LM) |
| 139 | 31843A | 1 | Governor Gear Bracket |
| 140 | 650965 | 2 | Screw, Torx T-25, 10-24 x 1/2" |
| 149 | 27882 | 2 | Valve Spring Cap |
| 150 | 27881 | 2 | Valve Spring |
| 151 | 32581 | 2 | Valve Spring Keeper |
| 169 | 27896A | 2 | * Breather Gasket |
| 170 | 28423 | 1 | Breather Body |
| 171 | 28424 | 1 | Breather Element |
| 172 | 28425 | 1 | Valve Cover |
| 173 | 35350 | 1 | Breather Tube |
| 174 | 650128 | 2 | Screw, 10-24 x 1/2" |
| 182 | 650517 | 2 | Screw, 1/4-20 x 27/32" |
| 184 | 31688A | 1 | * Carburetor To Intake Pipe Gasket |
| 186 | 34661 | 1 | Governor Link |
| 200 | 34677 | 1 | Control Bracket (Incl. 19, 203 & 204) |
| 203 | 31342 | 1 | Compression Spring |
| 204 | 650549 | 1 | Screw, 5-40 x 7/16" |
| 206 | 610973 | 1 | Terminal |
| 207 | 34662 | 1 | Throttle Link |
| 209 | 650821 | 2 | Screw, 10-32 x 1/2" |
| 215 | 32410 | 1 | Control Knob |
| 224 | 27915A | 1 | * Intake Pipe Gasket |
| 238 | 28820 | 2 | Screw, 10-32 x 1/2" |
| 239 | 27272A | 1 | * Air Cleaner Gasket |
| 240 | 31691 | 1 | Air Cleaner Bracket |
| 243 | 650152 | 2 | Screw, 8-32 x 3/8" |
| 245 | 30727 | 1 | Air Cleaner Filter |
| 250 | 31715 | 1 | Air Cleaner Cover |
| 260 | 35887 | 1 | Blower Housing |
| 262 | 29747B | 2 | Screw, Torx T-40, 5/16-24 x 21/32" |
| 265 | 30939A | 1 | Cylinder Head Cover |
| 272 | 30196 | 2 | Screw, 5/16-18 x 3/4" |
| 273 | 34712 | 1 | Carburetor Flange |
| 274 | 35865 | 1 | * Exhaust Manifold Gasket |
| 275 | 36220 | 1 | Muffler |
| 277 | 30196 | 2 | Screw, 5/16-18 x 3/4" |
| 285 | 35287A | 1 | Starter Cup |
| 287 | 650926 | 3 | Screw, 8-32 x 21/64" |
| 290 | 29774 | 1 | Fuel Line (1.44/1.56") |
| 291 | 30962 | 1 | Fuel Line |
| 292 | 26460 | 7 | Fuel Line Clamp |
| 295 | 35857 | 1 | Fuel Shut-Off Valve |
| 296 | 34279B | 1 | Fuel Filter (Incl. 292) |
| 298 | 650665 | 2 | Screw, 1/4-15 x 3/4" |
| 300 | 34186A | 1 | Fuel Tank (Incl. 292 & 301) |
| 301 | 36246 | 1 | Fuel Cap |

| Ref # | Part Number | Qty | Description |
|-------|-------------|-----|--|
| 305 | 35554 | 1 | Oil Fill Tube |
| 307 | 35499 | 1 | "O" Ring |
| 308 | 35540 | 1 | Fill Tube Clip |
| 310 | 36205 | 1 | Dipstick |
| 325 | 29443 | 1 | Wire Clip |
| 340 | 34159 | 1 | Fuel Tank Bracket |
| 341 | 34158 | 1 | Fuel Tank Bracket |
| 342 | 650561 | 1 | Screw, 1/4-20 x 5/8" |
| 370K | 36695 | 1 | Starter Decal |
| 370A | 35274 | 1 | Instruction Decal |
| 370 | 36261 | 1 | Instruction Decal |
| 370B | 35703 | 1 | Control Decal |
| 380 | 632230 | 1 | Carburetor (Incl. 184) |
| 390 | 590732 | 1 | Rewind Starter (Note: This engine could have been built with 590688 starter. Refer to the design of the rope pulley strength ribs for part identification. Individual starter parts do not interchange.) |
| 400 | 36447 | 1 | * Gasket Set (Incl. items marked PK in notes) Incl. part #'s 26756 (1), 27272A (2), 27896A (2), 27915A (1), 29673 (1), 30684 (1), 31688A (1), 33629 (1), 34912 (1), 35865 (1), 36445 (1) |
| 420 | 730225 | 1 | SAE 30 4-Cycle Engine Oil (Quart) |
| 453 | 29538 | 1 | Engine Mounting Base |
| 454 | 650542 | 4 | Screw, 5/16-18 x 3/4" |

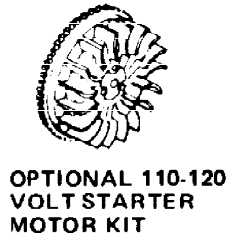
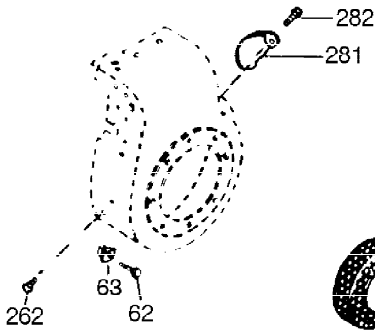
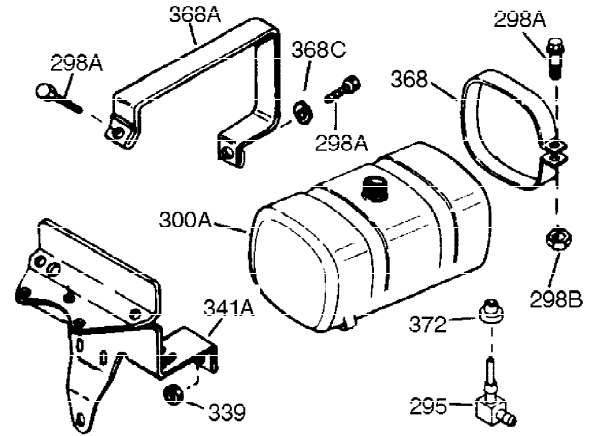
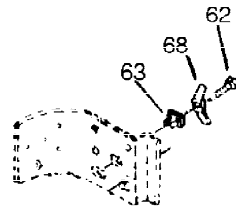
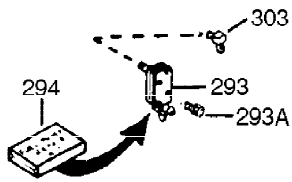

**OPTIONAL 110-120
VOLT STARTER
MOTOR KIT**

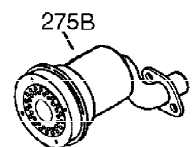
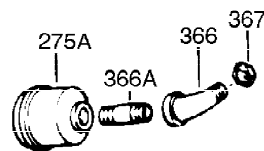
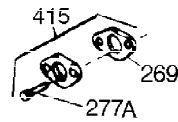
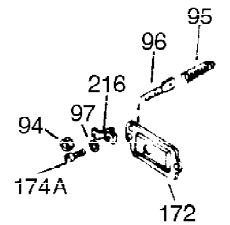
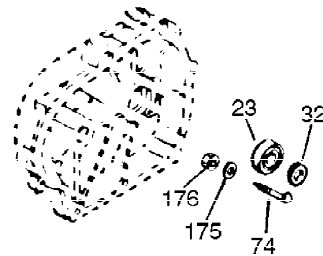
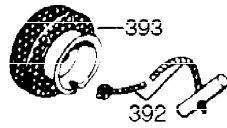
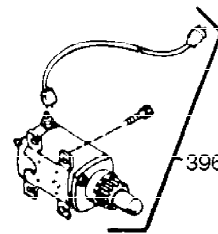

| Ref # | Part Number | Qty | Description |
|-------|-------------|-----|------------------------------------|
| 23 | 31793 | 1 | Ball Bearing |
| 32 | 31792 | 1 | Washer |
| 74 | 31855 | 2 | Bearing Retainer |
| 172 | 28425 | 1 | Valve Cover |
| 175 | 650778 | 2 | Lock Washer |
| 176 | 650580 | 2 | Lock Nut, 10-24 |
| 240 | 31691 | 1 | Air Cleaner Bracket |
| 262 | 29747B | 2 | Screw, Torx T-40, 5/16-24 x 21/32" |
| 274 | 35865 | 1 | * Exhaust Manifold Gasket |
| 295 | 35857 | 1 | Fuel Shut-Off Valve |

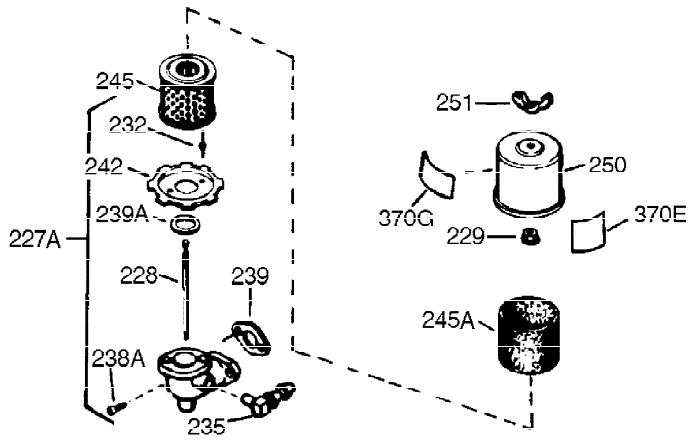

**OPTIONAL
STARTER MUFF KIT**

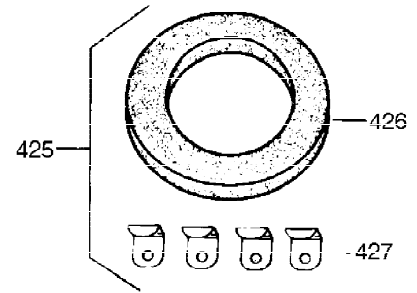

730571
Can be used on H50-60 with
stamped steel starter.

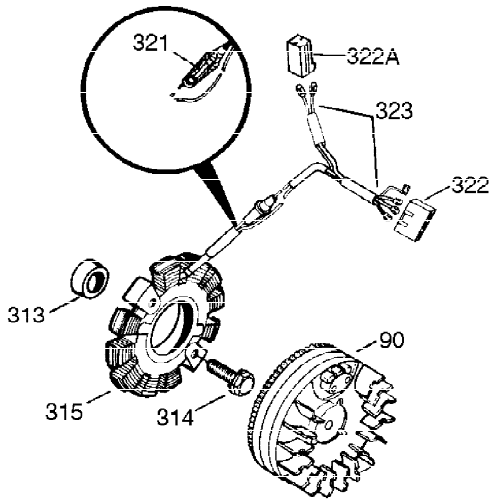

| Ref # | Part Number | Qty | Description |
|-------|-------------|-----|---------------------------|
| 90 | 611084 | 1 | Flywheel |
| 239 | 27272A | 1 | * Air Cleaner Gasket |
| 240 | 31691 | 1 | Air Cleaner Bracket |
| 245 | 30727 | 1 | Air Cleaner Filter |
| 250 | 31715 | 1 | Air Cleaner Cover |
| 274 | 35865 | 1 | * Exhaust Manifold Gasket |