

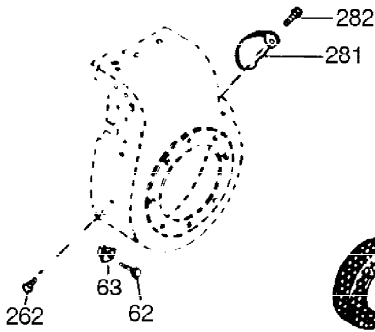

Ref #	Part Number	Qty	Description
1	35123A	1	Cylinder (Incl. 2, 20 & 72)
2	27652	2	Dowel Pin
15A	30700	1	Governor Yoke
15	30699C	1	Governor Rod (Incl. 15A & 15B)
15B	650494	1	Screw, 6-40 x 5/16"
16	33454	1	Governor Lever
17	29916	1	Governor Lever Clamp
18	650548	1	Screw, 8-32 x 5/16"
19	34663	1	Speed Control Spring
20	32630	1	Oil Seal
25	29536	1	Blower Housing Baffle
26	650561	2	Screw, 1/4-20 x 5/8"
28	30322	1	Lock Nut, 8-32
30	35223	1	Crankshaft
35	29826	1	Screw, 10-32 x 3/4"
36	29918	1	Lock Washer
37	29216	1	Lock Nut, 10-32
38	29642	1	Retaining Ring
40	34531	1	Piston, Pin & Ring Set (Std.)
40	34532	1	Piston, Pin & Ring Set (.010" OS)
40	34533	1	Piston, Pin & Ring Set (.020" OS)
41	33312B	1	Piston & Pin Ass'y. (Std.) (Incl. 43)
41	33313B	1	Piston & Pin Ass'y. (.010" OS) (Incl. 43)
41	33314B	1	Piston & Pin Ass'y. (.020" OS) (Incl. 43)
42	34854	1	Ring Set (Std.)
42	34855	1	Ring Set (.010" OS)
42	34856	1	Ring Set (.020" OS)
43	27888	2	Piston Pin Retaining Ring
45	31380C	1	Connecting Rod Ass'y. (Incl. 46)
46	650662C	2	Connecting Rod Bolt
48	34034	2	Valve Lifter
50	33156	1	Camshaft (BCR)
60	30622A	1	Blower Housing Extension
65	650128	1	Screw, 10-24 x 1/2"
69	30684	1	* Cylinder Cover Gasket
70	31451A	1	Cylinder Cover (Incl. 75,80,175 &176)
72	27642	2	Oil Drain Plug
75	28460	1	Oil Seal
80	31845	1	Governor Shaft
81	30590A	1	Washer
82	30591	1	Governor Gear Ass'y. (Incl. 81)
83	30588A	1	Governor Spool
84	29193	1	Retaining Ring
86	650488	7	Screw, 1/4-20 x 1-1/4"
87	650493	1	Screw, 1/4-20 x 1-3/4"
89	32589	1	Flywheel Key
90	611084	1	Flywheel
92	650815	1	Belleville Washer
93	8116	1	Flywheel Nut
100	34443A	1	Solid State Ignition
101	610118	1	Spark Plug Cover
102	650872	2	Solid State Mounting Stud
103	651007	2	Screw, Torx T-15, 10-24 x 15/16"
110	35187	1	Ground Wire
119	36445	1	* Cylinder Head Gasket

Ref #	Part Number	Qty	Description
120	36446	1	Cylinder Head (Incl. 3 of 130)
125	27878A	1	Exhaust Valve (Std.) (Incl. 151)
125	27880A	1	Exhaust Valve (1/32" OS) (Incl. 151)
126	32783	1	Intake Valve (Std.) (Incl. 151)
126	32784	1	Intake Valve (1/32" OS) (Incl. 151)
127	650691	3	Washer
128	650690	3	Belleville Washer
130	650697A	8	Screw, 5/16-18 x 2-1/2"
135	33636	1	Resistor Spark Plug (J8C/356)
139	31843A	1	Governor Gear Bracket
140	650965	2	Screw, Torx T-25, 10-24 x 1/2"
149	27882	2	Valve Spring Cap
150	27881	2	Valve Spring
151	32581	2	Valve Spring Keeper
169	27896A	2	* Valve Cover Gasket
170	28423	1	Breather Body
171	28424	1	Breather Element
172	28425	1	Valve Cover
173	35350	1	Breather Tube
174	650128	2	Screw, 10-24 x 1/2"
182	650517	2	Screw, 1/4-20 x 27/32"
184	31688A	1	* Carburetor To Intake Pipe Gasket
186	34661	1	Governor Link
200	34677	1	Control Bracket (Incl. 19, 203 & 204)
203	31342	1	Compression Spring
204	650549	1	Screw, 5-40 x 7/16"
206	610973	1	Terminal
207	34662	1	Throttle Link
209	650821	2	Screw, 10-32 x 1/2"
215	32410	1	Control Knob
224	27915A	1	* Intake Pipe Gasket
238	28820	2	Screw, 10-32 x 1/2"
239	27272A	1	* Air Cleaner Gasket
242	31914	1	Air Cleaner Bracket
243	650152	2	Screw, 8-32 x 3/8"
245	31700	1	Air Cleaner Filter
250	31715	1	Air Cleaner Cover
260	35887	1	Blower Housing
262	29747B	2	Screw, Torx T-40, 5/16-24 x 21/32"
265	30939A	1	Cylinder Head Cover
272	30196	2	Screw, 5/16-18 x 3/4"
273	34712	1	Carburetor Flange
274	35865	1	* Exhaust Manifold Gasket
275	36220	1	Muffler
277	30196	1	Screw, 5/16-18 x 3/4"
285	35287B	1	Starter Cup
287	650926	3	Screw, 8-32 x 21/64"
290	30962	1	Fuel Line
292	26460	2	Fuel Line Clamp
298	650665	2	Screw, 1/4-15 x 3/4"
300	34186A	1	Fuel Tank (Incl. 292 & 301)
301	36246	1	Fuel Cap
305	35554	1	Oil Fill Tube
307	35499	1	"O" Ring
308	35540	1	Fill Tube Clip

Ref #	Part Number	Qty	Description
310	36205	1	Dipstick
325	29443	1	Wire Clip
340	34159	1	Fuel Tank Bracket
341	34158	1	Fuel Tank Bracket
342	650561	1	Screw, 1/4-20 x 5/8"
370K	36695	1	Starter Decal
370A	35703	1	Throttle Decal
370B	35274	1	Instruction Decal
370	36261	1	Instruction Decal
380	632230	1	Carburetor (Incl. 184)
390	590732	1	Rewind Starter (Note: This engine could have been built with 590738 starter. Refer to the design of the rope pulley strength ribs for part identification. Individual starter parts do not interchange. Refer to service bulletin number 518.)
400	36447	1	* Gasket Set (Incl. items marked PK i n notes) Incl. part #'s 26756 (1), 27272A (1), 27896A (2), 27915A (1), 29673 (1), 30684 (1), 31688A (1), 33629 (1), 34912 (1), 35865 (1), 36445 (1)
420	730225	1	SAE 30 4-Cycle Engine Oil (Quart)
453	29538	1	Engine Mounting Base
454	650542	4	Screw, 5/16-18 x 3/4"



**OPTIONAL 110-120  
VOLT STARTER  
MOTOR KIT**

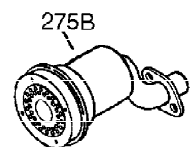
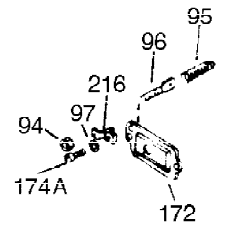
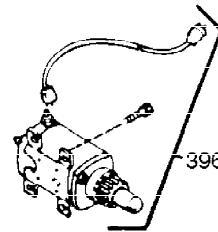

Ref #	Part Number	Qty	Description
23	31793	1	Ball Bearing
32	31792	1	Washer
74	31855	2	Bearing Retainer
172	28425	1	Valve Cover
175	650778	2	Lock Washer
176	650580	2	Lock Nut, 10-24
262	29747B	2	Screw, Torx T-40, 5/16-24 x 21/32"
274	35865	1	* Exhaust Manifold Gasket

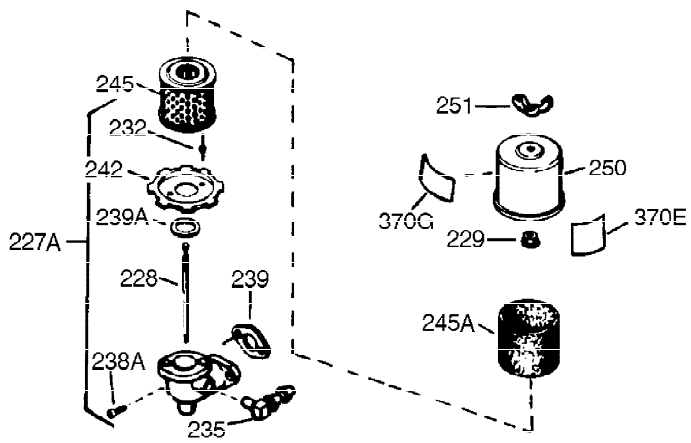

**OPTIONAL  
STARTER MUFF KIT**

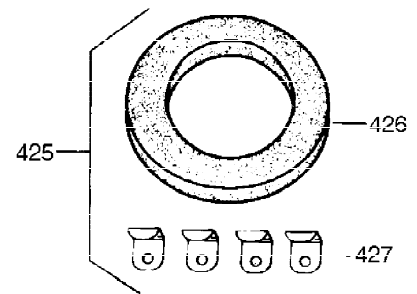

730571

Can be used on H50-60 with  
stamped steel starter.

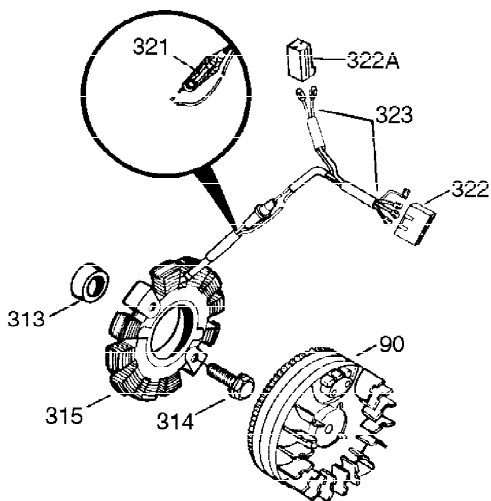

---

Ref #	Part Number	Qty	Description
90	611084	1	Flywheel
239	27272A	1	* Air Cleaner Gasket
242	31914	1	Air Cleaner Bracket
245	31700	1	Air Cleaner Filter
250	31715	1	Air Cleaner Cover
274	35865	1	* Exhaust Manifold Gasket