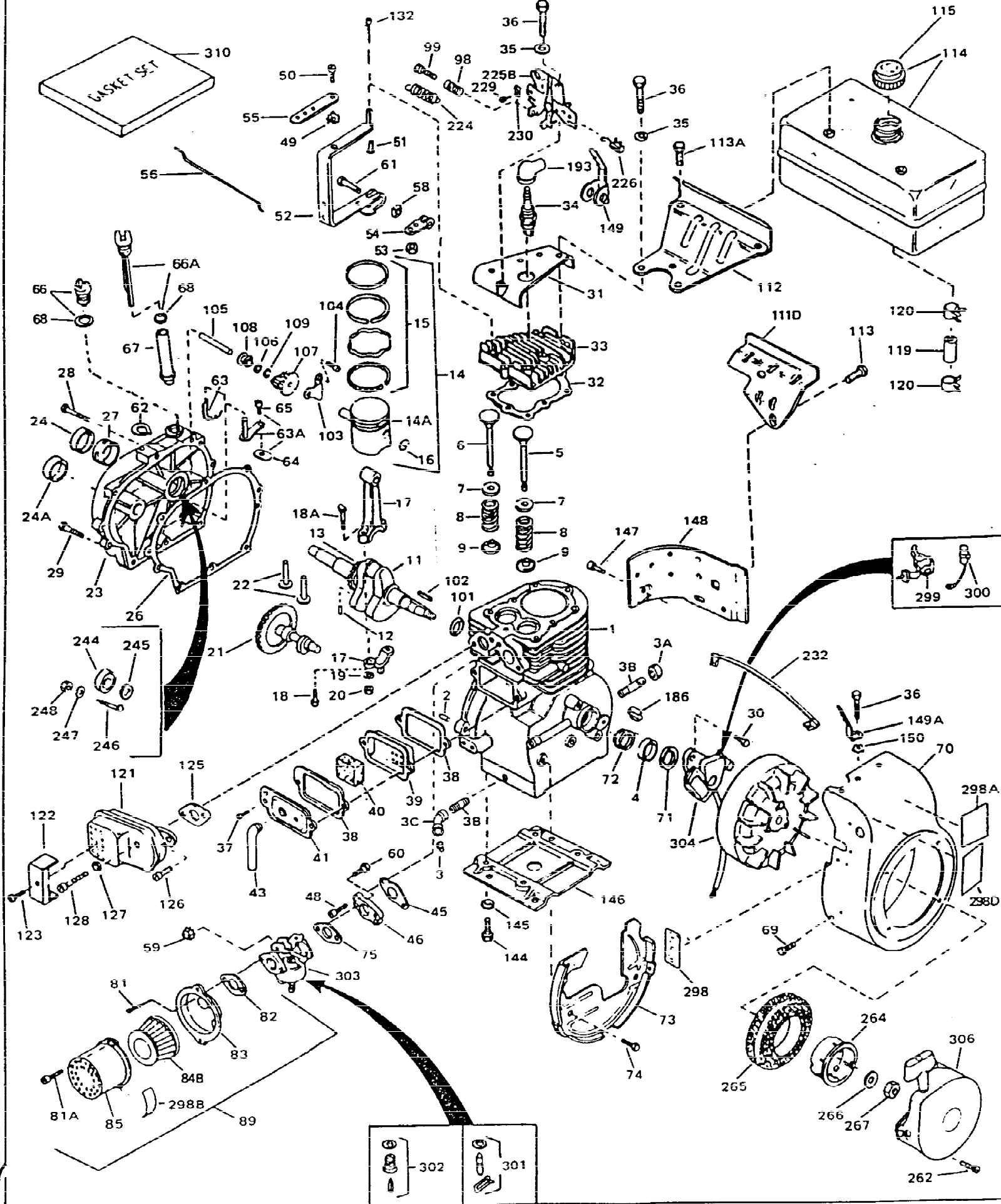

ILLUSTRATION SHOWS TYPICAL PARTS ONLY. ORDER BY PART NUMBER. PARTS NOT LISTED ARE SUPPLIED BY OEM.



Ref #	Part Number	Qty	Description
1	33311B		Cylinder (Incl. 2,3,4,5,184) (2-5/8" Bore)
2	27652		Pin, Dowel
3	27642		Plug, Oil drain, 1/4-18
4	27876B		Seal, Oil
5	32783		Intake Valve (Std.) (Incl. 9)
5	32784		Intake Valve (1/32" OS) (Incl. 9)
6	27878A		Exhaust Valve (Std.)
6	27880A		Exhaust Valve (1/32" OS) (Incl. 9)
7	27882		Cap, Upper valve spring
8	27881		Spring, Valve
9	32581		Cap, Lower valve spring
11	31827		Crankshaft (Incl. 12 & 13)
12	29783		Pin, Crankshaft gear Used in early production. This gear is serviceable ONLY when it is pinned to the crankshaft.
13	27884		Gear, Crankshaft Used in early production. This gear is serviceable ONLY when it is pinned to the crankshaft.
14A	33312B		Piston & Pin Ass'y. (Std.)(2-5/8")(In cl.16)
14A	33313B		Piston & Pin Ass'y. (.010" OS) (Incl. 16)
14A	33314B		Piston & Pin Ass'y. (.020" OS) (Incl. 16)
14	34531		Piston, Pin & Ring Set (Std.) (2-5/8" Bore)
14	34532		Piston, Pin & Ring Set (.010" OS)
14	34533		Piston, Pin & Ring Set (.020" OS)
15	34854		Ring Set (Std.) (2-5/8" Bore)
15	34855		Ring Set (.010" OS)
15	34856		Ring Set (.020" OS)
16	27888		Ring, Piston pin retaining
17	31380C		Rod Assy., Connecting (Incl. 18)
18	650662C		Screw, Connecting rod (Late production)
18A	30682		Bolt, Connecting rod (Early production)
19	26073		Connecting rod bolt washer (Early production)
20	28264		Connecting rod nut (Used on early production)
21	33156		Camshaft
22	34034		Lifter, Valve
23	31451A		Cylinder Cover (Incl.24, 105, 246, 247 & 248)
24	28460		Seal, Oil
26	30684		* Gasket, Cylinder cover
28	650488		Screw, 1/4-20 x 1-1/4"
29	650493		Screw, 1/4-20 x 1-3/4"
30	650489		Screw, 1/4-20 x 5/8"
31	30939A		Cover, Cylinder head
32	28938C		* Gasket, Cylinder head
33	30938A		Head, Cylinder (Incl. 3 of 36)
34	33636		Resistor Spark Plug
35	26073		Washer, Flat (Use as required)
35	650570		Washer, Flat (Use as required)
35	650691		Washer, Flat (Use as required)
36	650697A		Screw, 5/16-18 x 2-1/2" (Use as required)
36	650695A		Screw, 5/16-18 x 2-1/4" (Use as required)
36	650694A		Screw, 5/16-18 x 2" (Use as required)
37	650128		Screw, 10-24 x 1/2" (Use as required)
37	650597		Screw, 10-24 x 5/8" (Use as required)
38	27896A		* Gasket, Breather cover

Ref #	Part Number	Qty	Description
39	28423		Body, Breather
40	28424		Element, Breather
41	28425		Cover, Valve spring
45	27915A		* Gasket, Intake
46	30195A		Flange, Carburetor (Incl. 79 & 80)
48	30196		Screw, 5/16-18 x 3/4"
49	29918		Lockwasher
50	650548		Screw, 8-32 x 5/16"
51	30319		Rivet, Split (Used on early production)
52	32326A		Lever, Governor (New lever does not need 1 of Ref #49,51,53,54,132,133)
53	30322		Lock Nut, 8-32 (Use as required)
54	29916		Clamp, Governor lever (Use as required)
55	30205		Bracket, Adjusting
56	31710		Link, Throttle
58	29216		Locknut, 10-32
59	29752		Nut & Lockwasher, 1/4-28
60	650572		Screw, 1/4-28 x 1-1/8"
61	29826		Screw, 10-32 x 3/4"
62	29642		Ring, Retaining
63	30699B		Rod Assy., Governor (This one piece gov. rod is no longer used. It is replaced by 30699C assy., Ref.#63A)
63A	30699C		Rod Assy., Governor (Incl. 64 & 65)
64	30700		Yoke, Governor
65	650494		Screw, 6-40 x 5/16"
66A	31297		Dipstick (Incl. 68)
68	29673		* Gasket, Dipstick
69	29747B		Screw, 5/16-24 x 21/32"
70	32158E		Blower Hsg. (For elec.starter)(Incl.1 89,190)
73	29536		Baffle, Blower housing
74	650561		Screw, 1/4-20 x 5/8"
75	31688A		* Gasket, Carburetor
81	30196		Screw, 5/16-18 x 3/4" (Use as required)
81	28820		Screw, 10-32 x 1/2" (Use as required)
81	650521		Screw, 10-32 x 1-1/8" (Use as required)
81A	650152		Screw, 8-32 x 3/8"
82	27272A		* Gasket, Air cleaner
83	31691		Bracket, Air cleaner
84B	30727		Element, Air cleaner
85	31715		Body, Air cleaner
89	730127		Air Cleaner Ass'y. (Incl. 81,81A,82,83,84,85,90G & 298B) (Use as required)
98	28569		Compression Spring (Used with 29500 screw)(Use as required)
98	32924		Compression Spring (Used with 650688 screw) (Use as required)
98	31342		Compression Spring (Used with 650549 screw) (Use as required)
99	650688		Screw, 10-32 x 1 (Use as required)
99	650549		Screw, 5-40 x 7/16" (Use as required)
99	29500		Screw, 8-32 x 3/4" (Use as required)

Ref #	Part Number	Qty	Description
102	30884		Key, Flywheel
103	31843A		Bracket, Governor gear
104	650836		Screw, 10-24 x 1/2"
105	31845		Shaft, Mechanical governor
106	30590A		Washer, Flat
107	30591		Gear Assy., Governor (Incl. 106)
108	30588A		Spool, Governor
109	29193		Ring, Retaining
113	30063		Screw, 1/4-20 x 1/2"
115	410144B		Fuel Cap (White Plastic)(Standard)(As req.)
115	33032		Fuel Cap (Red Plastic) (Spurt Resistant, Low Profile) (Use as required)
115	34210		Fuel Cap (Red Plastic) (Spurt Resistant, High Profile) (Use as required)
119	29774		Fuel Line (Braided 8.25") (Use as required)
119	30705		Fuel Line (Braided 16") (Use as required)
119	30962		Fuel Line (Braided 32") (Use as required)
120	26460		Clamp, Fuel line (Use as required)
125	27930A		* Gasket, Exhaust
132	650548		Screw, 8-32 x 5/16" (Early production )
132	650139		Screw, 8-32 x 1/2" (Early production)
144	650542		Screw, 5/16-18 x 3/4"
146	29538		Base, Engine mounting
147	650128		Screw, 10-24 x 1/2"
148	30622A		Extension, Blower housing
186	27275		Clip, Wire (Use as required)
186	29443		Clip, Fuel line (Use as required)
193	27276		Cover, Spark Plug
224	31386		Spring, Extension
225B	31726B		Control Bracket (Incl. 98, 99, 226 & 284A)
226	610973		Terminal Assy.
229	28942		Screw, 10-32 x 3/8"
230	27793		Clip, Conduit
244	31793		Bearing, Ball
245	31792		Washer, Thrust
246	31855		Retainer, Bearing
247	650778		Washer, Lock
248	650580		Nut, Lock
262	29716		Screw, 1/4-28 x 7/16"
264	32125		Cup, Starter
265	590417		Screen, Starter cup
266	650815		Washer, Belleville
267	8116		Nut, Hex
298A	550223		Decal, Name
298A	33310		Decal, 5 HP Mini-Bike (Use as required)
298A	31517		Decal, H.P. (5 H.P.) (Use as required )
298A	32173		Decal, H.P. (6 H.P.) (Use as required )
298B	31752		Decal, Air cleaner
298	34346		Decal, Instruction
299	30547A		Contact Assy., Breaker
300	30548B		Condenser
301	631021		Inlet Needle, Seat & Clip Assy.
303	631152		Carburetor (Incl. 301) (Refer to Division 5, Section A, page 64 for breakdown)

Ref #	Part Number	Qty	Description
304	610689A		Magneto NOTE: The complete magneto is not available as an assembly. The magneto number is shown for reference purposes only. Order component parts individually, as shown in parts list. (Refer to Division 5, Section B, page 24 for breakdown)
306	590420		Rewind Starter (Refer to Division 5, Section C, page 25 for breakdown)
310	33235A		* Gasket Set (Incl. items marked *)



Ref #	Part Number	Qty	Description
	35 26073		Washer, Flat (Use as required)
	35 650570		Washer, Flat (Use as required)
	35 650691		Washer, Flat (Use as required)
	36 650697A		Screw, 5/16-18 x 2-1/2" (Use as required)
	36 650695A		Screw, 5/16-18 x 2-1/4" (Use as required)
	36 650694A		Screw, 5/16-18 x 2" (Use as required)
	38 27896A		* Gasket, Breather cover
	81 30196		Screw, 5/16-18 x 3/4" (Use as required)
	81 28820		Screw, 10-32 x 1/2" (Use as required)
	81 650521		Screw, 10-32 x 1-1/8" (Use as required)
	82 27272A		* Gasket, Air cleaner
86A	31431		Elbow, Air cleaner
86A	34697		Air Cleaner Elbow Assy.(Use in 730561 only.)
	87 650163		Screw, 10-32 x 7/8"
89A	730128		Air Cleaner Ass'y. (Incl. 82,90A,90B,90D thru 90G,97 & 298B) (Use as req.)
111B	34823		Bracket, Lower fuel tank
114A	31977		Fuel Tank (Incl. 115)
117A	29683		Valve, Fuel strainer & shut-off
121E	391026		Muffler (Incl. 124, 124A & 124B) (This spark arrester muffler can be used on any model)
124A	33171		Muffler Screen (Use as required)
124B	33185		Cover & Tube, Muffler (Use as required)
	124 650578		Screw, 8-18 x 3/8"
	125 27930A		* Gasket, Exhaust
	134 31288		Muf.Adapter Kit(Incl.125,136,137)(As req.)
	135 730130		Muf.Adapter Kit(Incl.125 & 138)(As required)
	136 6021A		Screw, 5/16-18 x 1-1/2" (Use as required)
	137 650697A		Screw, 5/16-18 x 2-1/2" (Use as required)
	138 30196		Screw, 5/16-18 x 3/4" (Use as required)
	199 29212		Screw, 1/4-28 x 7/16"
	200 650570		Washer, Flat
201A	31979		Strap, Fuel tank
	204 650451		Screw, 1/4-20 x 1"
	205 650456		Nut, 1/4-20
	233 34819		Air Cleaner Elbow (Incl.44,76,78,83A,86A,100)(Use in 730561 ass'y. only)
	234 730561		Air Cleaner Kit (Incl.38,43,44,76,78,79,82,83A,84,84C,86A,87,90,100A) (Use only on engines with an externally vented fully adjustable carburetor.)
	273 650687		Screw, 10-32 x 5/16" (Use as required)

ILLUSTRATION SHOWS TYPICAL PARTS ONLY. ORDER BY PART NUMBER, PARTS NOT LISTED ARE SUPPLIED BY OEM.

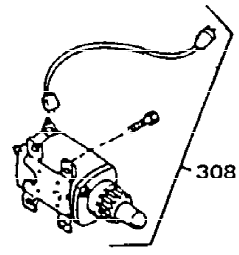
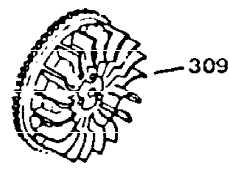

OPTIONAL 110-120  
VOLT STARTER  
MOTOR KIT

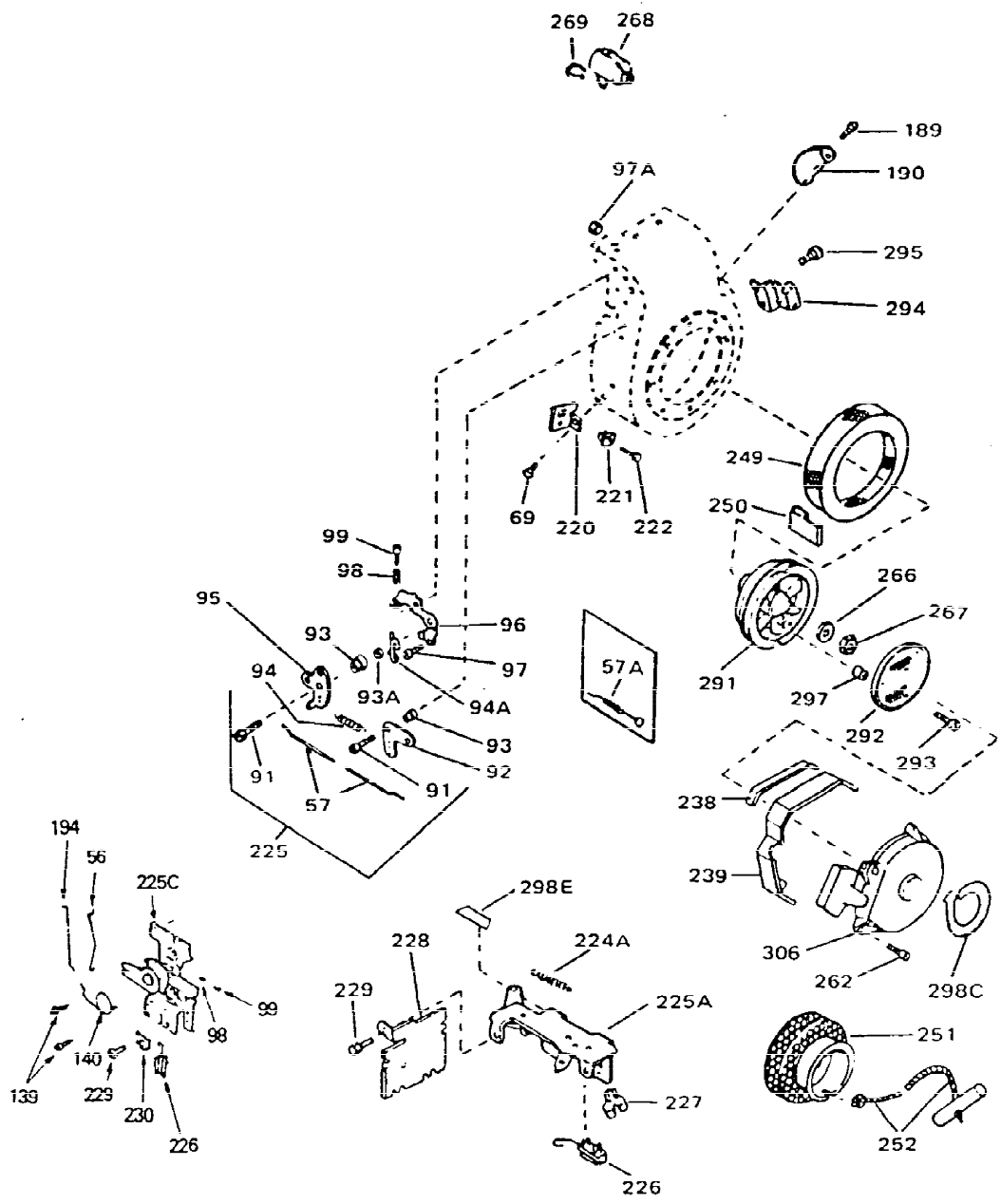
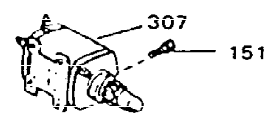
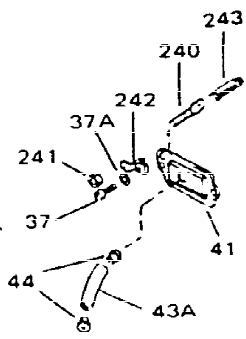
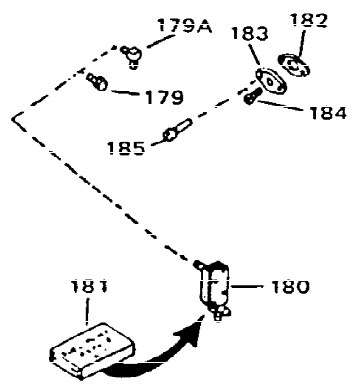



Ref #	Part Number	Qty	Description
37	650128		Screw, 10-24 x 1/2" (Use as required)
37	650597		Screw, 10-24 x 5/8" (Use as required)
37A	27261		Washer, Flat (Use as required)
41	28425		Cover, Valve spring
43A	35350		Tube, Breather
56	31710		Link, Throttle
69	29747B		Screw, 5/16-24 x 2 1/32"
98	28569		Compression Spring (Used with 29500 screw)(Use as required)
98	32924		Compression Spring (Used with 650688 screw) (Use as required)
98	31342		Compression Spring (Used with 650549 screw) (Use as required)
99	650688		Screw, 10-32 x 1 (Use as required)
99	650549		Screw, 5-40 x 7/16" (Use as required)
99	29500		Screw, 8-32 x 3/4" (Use as required)
182	32683A		Gasket, Fuel pump cover (Use as required)
183	32955		Cover, Fuel pump pad (Use as required)
184	9556		Plug, Pipe 1/8-27 (Use as required)
185	30063		Screw, 1/4-20 x 1/2" (Use as required)
225	730152		Control Bracket(Incl.91 thru 97)(As req.)
226	610973		Terminal Assy.
227	33177		Terminal (Use as required)
229	28942		Screw, 10-32 x 3/8"
230	27793		Clip, Conduit
262	29716		Screw, 1/4-28 x 7/16"
266	650815		Washer, Belleville
267	8116		Nut, Hex
305	33018		Harness Assy., Adapter (Use as required)
306	590420		Rewind Starter (Refer to Division 5, Section C, page 25 for breakdown)
308	33328D		Starter Motor Kit (110-120 Volt) NOTE: This 110-120 volt starter motor kit may have been added to this engine. This can be added only if cylinder has drilled and tapped starter mounting bosses and a ring gear flywheel has been added (see #309). Refer to service number stamped on end cap of motor,
309	30811A		Flywheel (Ring gear flywheel required on engines using 110-120 volt starter motor kits listed above.)