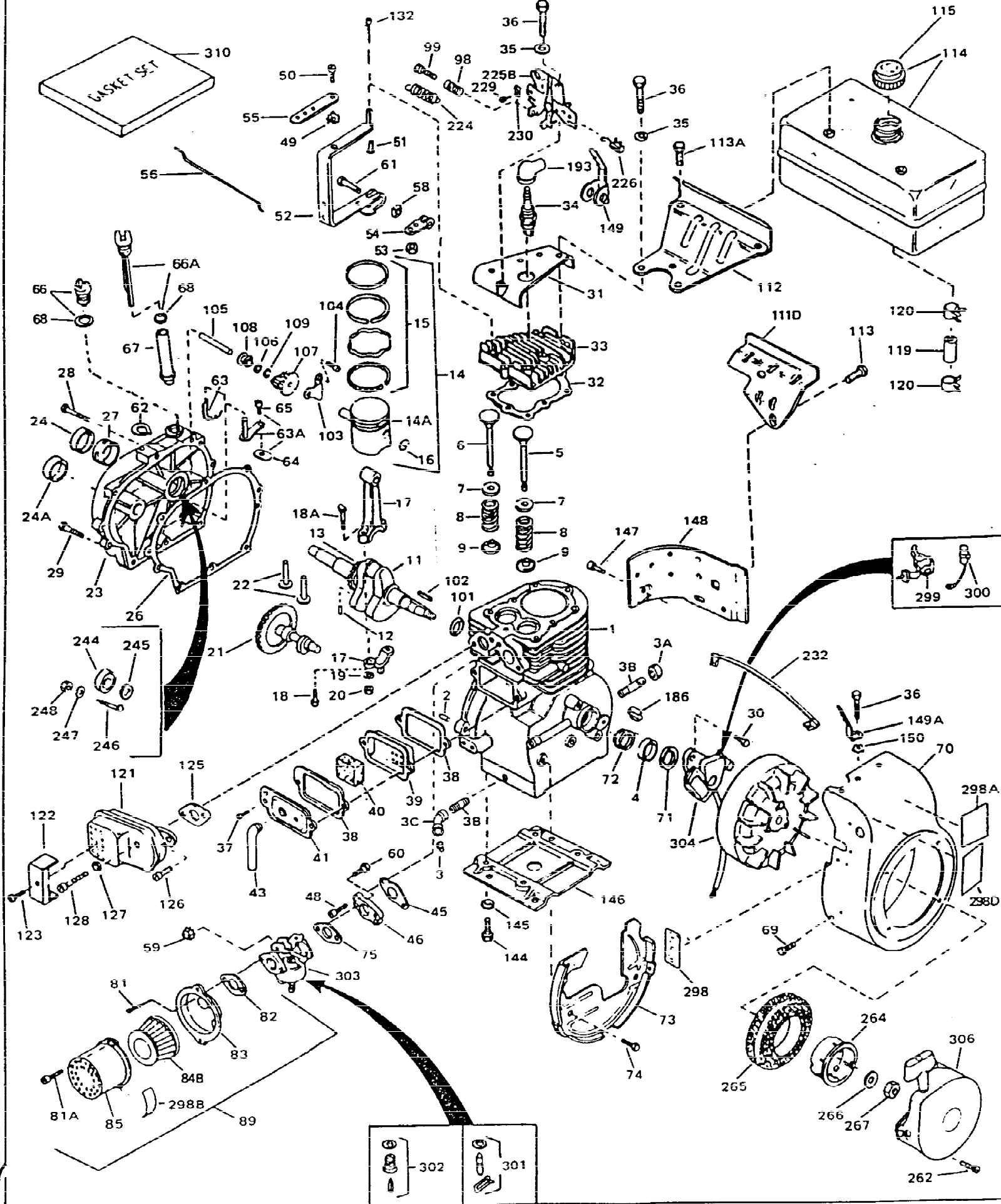

ILLUSTRATION SHOWS TYPICAL PARTS ONLY. ORDER BY PART NUMBER. PARTS NOT LISTED ARE SUPPLIED BY OEM.



Ref #	Part Number	Qty	Description
1	33311B		Cylinder (Incl. 2,3,4,5,184) (2-5/8" Bore)
2	27652		Pin, Dowel
3	27642		Plug, Oil drain, 1/4-18
3	9556		Pipe Plug, 1/8-27
4	27876B		Seal, Oil
5	32783		Intake Valve (Std.) (Incl. 9)
5	32784		Intake Valve (1/32" OS) (Incl. 9)
6	27878A		Exhaust Valve (Std.)
6	27880A		Exhaust Valve (1/32" OS) (Incl. 9)
7	27882		Cap, Upper valve spring
8	27881		Spring, Valve
9	32581		Cap, Lower valve spring
11	31827		Crankshaft (Incl. 12 & 13)
12	29783		Pin, Crankshaft gear Used in early production. This gear is serviceable ONLY when it is pinned to the crankshaft.
13	27884		Gear, Crankshaft Used in early production. This gear is serviceable ONLY when it is pinned to the crankshaft.
14	34531		Piston, Pin & Ring Set (Std.) (2-5/8" Bore)
14	34532		Piston, Pin & Ring Set (.010" OS)
14	34533		Piston, Pin & Ring Set (.020" OS)
14A	33312B		Piston & Pin Ass'y. (Std.)(2-5/8")(In cl.16)
14A	33313B		Piston & Pin Ass'y. (.010" OS) (Incl. 16)
14A	33314B		Piston & Pin Ass'y. (.020" OS) (Incl. 16)
15	34854		Ring Set (Std.) (2-5/8" Bore)
15	34855		Ring Set (.010" OS)
15	34856		Ring Set (.020" OS)
16	27888		Ring, Piston pin retaining
17	31380C		Rod Assy., Connecting (Incl. 18)
18A	30682		Bolt, Connecting rod (Early production)
18	650662C		Screw, Connecting rod (Late production)
19	26073		Connecting rod bolt washer (Early production)
20	28264		Connecting rod nut (Used on early production)
21	33156		Camshaft
22	34034		Lifter, Valve
23	31451A		Cylinder Cover (Incl.24, 105, 246, 247 & 248)
24	28460		Seal, Oil
26	30684		* Gasket, Cylinder cover
28	650488		Screw, 1/4-20 x 1-1/4"
29	650493		Screw, 1/4-20 x 1-3/4"
30	650516		Screw, 1/4-20 x 1-1/8"
31	30939A		Cover, Cylinder head
32	28938C		* Gasket, Cylinder head
33	30938A		Head, Cylinder (Incl. 3 of 36)
34	33636		Resistor Spark Plug
35	26073		Washer, Flat (Use as required)
35	650570		Washer, Flat (Use as required)
35	650691		Washer, Flat (Use as required)
36	650697A		Screw, 5/16-18 x 2-1/2" (Use as required)
36	650695A		Screw, 5/16-18 x 2-1/4" (Use as required)
36	650694A		Screw, 5/16-18 x 2" (Use as required)
37	650128		Screw, 10-24 x 1/2" (Use as required)
37	650597		Screw, 10-24 x 5/8" (Use as required)

Ref #	Part Number	Qty	Description
38	27896A		* Gasket, Breather cover
39	28423		Body, Breather
40	28424		Element, Breather
41	28425		Cover, Valve spring
45	27915A		* Gasket, Intake
46	34712		Flange, Carburetor (Incl. 60)
48	30196		Screw, 5/16-18 x 3/4"
49	29918		Lockwasher
50	650548		Screw, 8-32 x 5/16"
51	30319		Rivet, Split (Used on early production)
52	33454		Lever Assy., Governor
53	30322		Lock Nut, 8-32 (Use as required)
54	29916		Clamp, Governor lever (Use as required)
56	34662		Link, Throttle
58	29216		Locknut, 10-32
60	650517		Screw, 1/4-20 x 13/16"
61	29826		Screw, 10-32 x 3/4"
62	29642		Ring, Retaining
63A	30699C		Rod Assy., Governor (Incl. 64 & 65)
63	30699B		Rod Assy., Governor (This one piece gov. rod is no longer used. It is replaced by 30699C assy., Ref.#63A)
64	30700		Yoke, Governor
65	650494		Screw, 6-40 x 5/16"
66A	31297		Dipstick (Incl. 68)
68	29673		* Gasket, Dipstick
69	29747B		Screw, 5/16-24 x 21/32"
70	32158E		Blower Hsg. (For elec.starters)(Incl. 189,190)
71	33876		Gasket, Stator
73	29536		Baffle, Blower housing
74	650561		Screw, 1/4-20 x 5/8"
75	31688A		* Gasket, Carburetor
81	30196		Screw, 5/16-18 x 3/4" (Use as required)
81	28820		Screw, 10-32 x 1/2" (Use as required)
81	650521		Screw, 10-32 x 1-1/8" (Use as required)
81A	650152		Screw, 8-32 x 3/8"
82	27272A		* Gasket, Air cleaner
83	31691		Bracket, Air cleaner
84B	30727		Element, Air cleaner
85	31715		Body, Air cleaner
89	730127		Air Cleaner Ass'y. (Incl. 81,81A,82,83,84,85,90G & 298B) (Use as required)
98	28569		Compression Spring (Used with 29500 screw)(Use as required)
98	32924		Compression Spring (Used with 650688 screw) (Use as required)
98	31342		Compression Spring (Used with 650549 screw) (Use as required)
99	650549		Screw, 5-40 x 7/16" (Use as required)
99	29500		Screw, 8-32 x 3/4" (Use as required)
99	650688		Screw, 10-32 x 1 (Use as required)
102	30884		Key, Flywheel
103	31843A		Bracket, Governor gear

Ref #	Part Number	Qty	Description
104	650836		Screw, 10-24 x 1/2"
105	31845		Shaft, Mechanical governor
106	30590A		Washer, Flat
107	30591		Gear Assy., Governor (Incl. 106)
108	30588A		Spool, Governor
109	29193		Ring, Retaining
111D	34158		Bracket, Lower fuel tank
112	34159		Plate, Upper fuel tank mtg.
113A	650665		Screw, 1/4-15 x 3/4"
113	650561		Screw, 1/4-20 x 5/8"
114	34186A		Fuel Tank (Incl. 115 & 120)
115	410144B		Fuel Cap (White Plastic)(Standard)(As req.)
115	33032		Fuel Cap (Red Plastic) (Spurt Resistant, Low Profile) (Use as required)
115	34210		Fuel Cap (Red Plastic) (Spurt Resistant, High Profile) (Use as required)
119	29774		Fuel Line (Braided 8.25") (Use as required)
119	30705		Fuel Line (Braided 16") (Use as required)
119	30962		Fuel Line (Braided 32") (Use as required)
120	26460		Clamp, Fuel line (Use as required)
121	32401		Muffler
125	27930A		* Gasket, Exhaust
126	30196		Screw, 5/16-18 x 3/4"
127	26073		Washer, Flat
128	650694A		Screw, 5/16-18 x 2"
132	650548		Screw, 8-32 x 5/16" (Early production)
132	650139		Screw, 8-32 x 1/2" (Early production)
144	650542		Screw, 5/16-18 x 3/4"
146	29538		Base, Engine mounting
147	650128		Screw, 10-24 x 1/2"
148	30622A		Extension, Blower housing
186	27275		Clip, Wire (Use as required)
186	29443		Clip, Fuel line (Use as required)
229	28942		Screw, 10-32 x 3/8"
230	27793		Clip, Conduit
244	31793		Bearing, Ball
245	31792		Washer, Thrust
246	31855		Retainer, Bearing
247	650778		Washer, Lock
248	650580		Nut, Lock
262	29716		Screw, 1/4-28 x 7/16"
264	32125		Cup, Starter
265	35009		Screen, Starter cup
266	650815		Washer, Belleville
267	8116		Nut, Hex
298A	550223		Decal, Name
298A	33310		Decal, 5 HP Mini-Bike (Use as required)
298A	31517		Decal, H.P. (5 H.P.) (Use as required)
298A	32173		Decal, H.P. (6 H.P.) (Use as required)
298	34346		Decal, Instruction
299	30547A		Contact Assy., Breaker
300	610767A		Condenser
301	631021		Inlet Needle, Seat & Clip Assy.

Ref #	Part Number	Qty	Description
303	632178		Carburetor (Incl. 75 & 301) (Refer to Division 5, Section A, page 176 for breakdown)
304	610984		Magneto (w/ring gear) (12 Volt) (3 Am p) NOTE: The complete magneto is not available as an assembly. The magneto number is shown for reference purposes only. Order component parts individually, as shown in parts list. (Refer to Division 5, Section B, page 36 for breakdown)
306	590420		Rewind Starter (Refer to Division 5, Section C, page 25 for breakdown)
310	33235A		* Gasket Set (Incl. items marked *)

Ref #	Part Number	Qty	Description
	35 26073		Washer, Flat (Use as required)
	35 650570		Washer, Flat (Use as required)
	35 650691		Washer, Flat (Use as required)
	36 650697A		Screw, 5/16-18 x 2-1/2" (Use as required)
	36 650695A		Screw, 5/16-18 x 2-1/4" (Use as required)
	36 650694A		Screw, 5/16-18 x 2" (Use as required)
	38 27896A		* Gasket, Breather cover
	81 30196		Screw, 5/16-18 x 3/4" (Use as required)
	81 28820		Screw, 10-32 x 1/2" (Use as required)
	81 650521		Screw, 10-32 x 1-1/8" (Use as required)
	82 27272A		* Gasket, Air cleaner
	86A 34697		Air Cleaner Elbow Assy.(Use in 730561 only.)
	89A 730128		Air Cleaner Ass'y. (Incl. 82,90A,90B,90D thru 90G,97 & 298B) (Use as req.)
	113A 650665		Screw, 1/4-15 x 3/4"
	121E 391026		Muffler (Incl. 124, 124A & 124B) (This spark arrester muffler can be used on any model)
	124A 33171		Muffler Screen (Use as required)
	124B 33185		Cover & Tube, Muffler (Use as required)
	124 650578		Screw, 8-18 x 3/8"
	125 27930A		* Gasket, Exhaust
	134 31288		Muf.Adapter Kit(Incl.125,136,137)(As req.)
	135 730130		Muf.Adapter Kit(Incl.125 & 138)(As required)
	136 6021A		Screw, 5/16-18 x 1-1/2" (Use as required)
	137 650697A		Screw, 5/16-18 x 2-1/2" (Use as required)
	138 30196		Screw, 5/16-18 x 3/4" (Use as required)
	233 34819		Air Cleaner Elbow (Incl.44,76,78,83A,86A,100)(Use in 730561 ass'y. only)
	234 730561		Air Cleaner Kit (Incl.38,43,44,76,78,79,82,83A,84,84C,86A,87,90,100A) (Use only on engines with an externally vented fully adjustable carburetor.)
	273 650687		Screw, 10-32 x 5/16" (Use as required)

ILLUSTRATION SHOWS TYPICAL PARTS ONLY. ORDER BY PART NUMBER, PARTS NOT LISTED ARE SUPPLIED BY OEM.

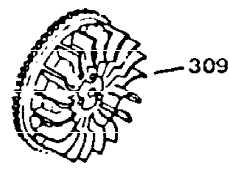

OPTIONAL 110-120
VOLT STARTER
MOTOR KIT

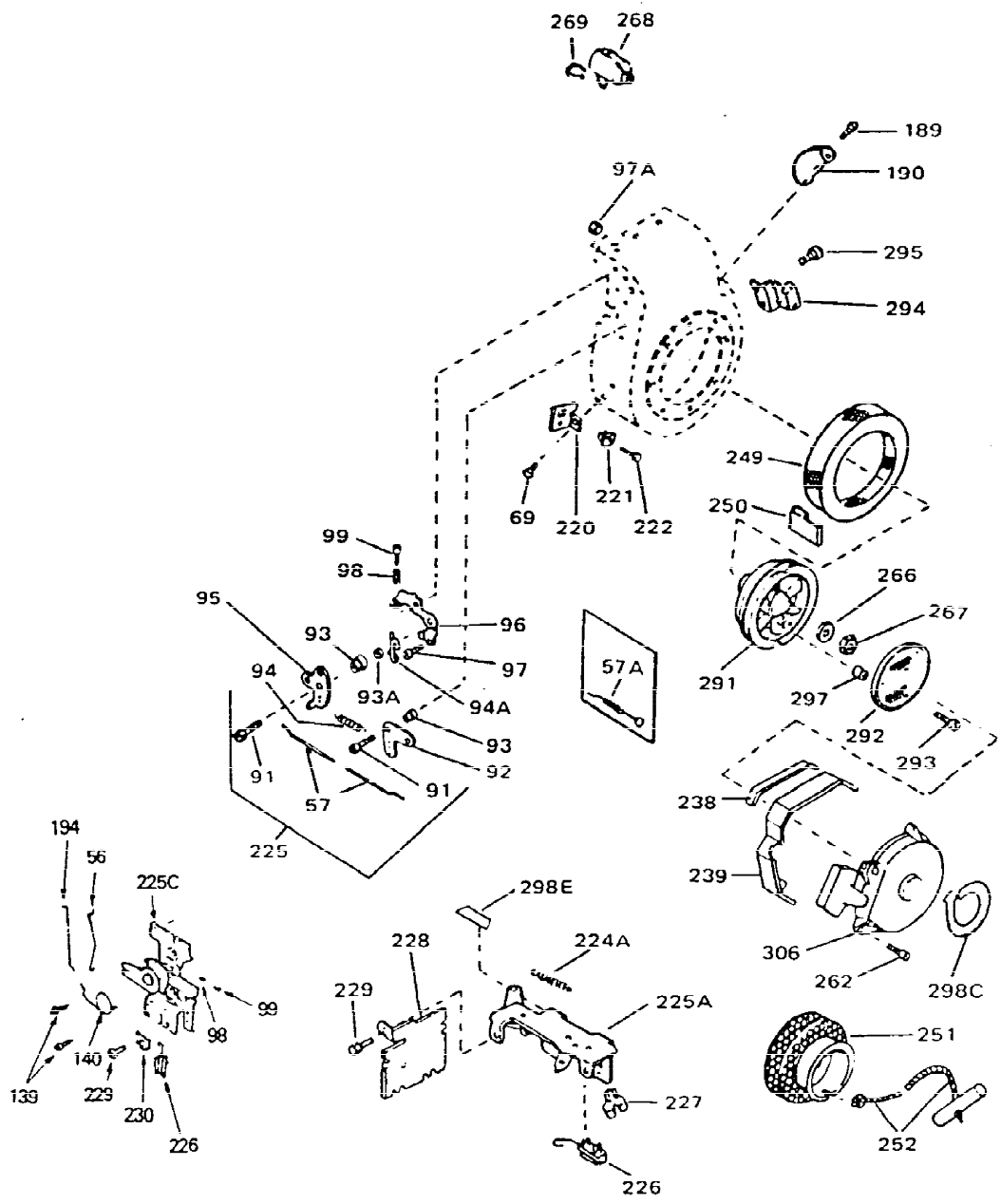
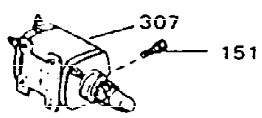
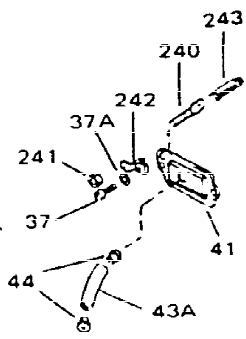
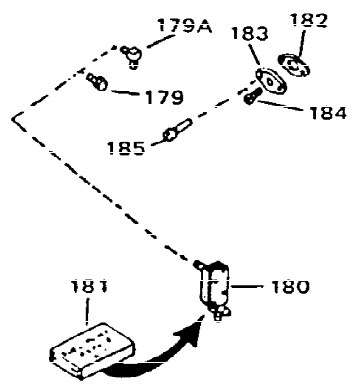
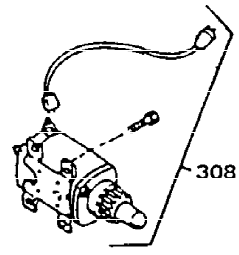

Ref #	Part Number	Qty	Description
37A	27261		Washer, Flat (Use as required)
37	650128		Screw, 10-24 x 1/2" (Use as required)
37	650597		Screw, 10-24 x 5/8" (Use as required)
41	28425		Cover, Valve spring
43A	35350		Tube, Breather
56	34662		Link, Throttle
57A	30985		Control, Throttle
69	29747B		Screw, 5/16-24 x 21/32"
98	28569		Compression Spring (Used with 29500 screw)(Use as required)
98	32924		Compression Spring (Used with 650688 screw) (Use as required)
98	31342		Compression Spring (Used with 650549 screw) (Use as required)
99	650549		Screw, 5-40 x 7/16" (Use as required)
99	29500		Screw, 8-32 x 3/4" (Use as required)
99	650688		Screw, 10-32 x 1 (Use as required)
139	650821		Screw, 10-32 x 1/2"
140	34663		Spring, Speed control
151	30063		Screw, 1/4-20 x 1/2"
182	32683A		Gasket, Fuel pump cover (Use as required)
183	32955		Cover, Fuel pump pad (Use as required)
184	9556		Plug, Pipe 1/8-27 (Use as required)
185	30063		Screw, 1/4-20 x 1/2" (Use as required)
192	34067		Wire Harness (4-1/4")
192	34068		Wire Harness (6-1/4")
225C	34664		Control Bracket (Incl. 98, 99, 140 & 226)
225	730152		Control Bracket(Incl.91 thru 97)(As req.)
227	33177		Terminal (Use as required)
229	28942		Screw, 10-32 x 3/8"
230	27793		Clip, Conduit
262	29716		Screw, 1/4-28 x 7/16"
266	650815		Washer, Belleville
267	8116		Nut, Hex
305	33018		Harness Assy., Adapter (Use as required)
306	590420		Rewind Starter (Refer to Division 5, Section C, page 25 for breakdown)
308	33328D		Starter Motor Kit (110-120 Volt) NOTE: This 110-120 volt starter motor kit may have been added to this engine. This can be added only if cylinder has drilled and tapped starter mounting bosses and a ring gear flywheel has been added (see #309). Refer to service number stamped on end cap of motor,
309	30811A		Flywheel (Ring gear flywheel required on engines using 110-120 volt starter motor kits listed above.)