

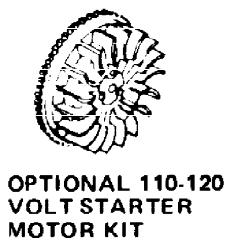

| Ref # | Part Number | Qty | Description |
|-------|-------------|-----|---|
| 1 | 34919B | 1 | Cylinder (Incl. 2, 20 & 72) |
| 2 | 27652 | 2 | Dowel Pin |
| 15A | 30700 | 1 | Governor Yoke |
| 15 | 30699C | 1 | Governor Rod (Incl. 15A & 15B) |
| 15B | 650494 | 1 | Screw, 6-40 x 5/16" |
| 16 | 33454 | 1 | Governor Lever |
| 17 | 29916 | 1 | Governor Lever Clamp |
| 18 | 651028 | 1 | Screw, Torx T-15, 8-32 x 3/8" |
| 19 | 34663 | 1 | Speed Control Spring |
| 20 | 32630 | 1 | Oil Seal |
| 25 | 29536 | 1 | Blower Housing Baffle |
| 26 | 650561 | 2 | Screw, 1/4-20 x 5/8" |
| 28 | 33032 | 1 | Lock Nut, 8-32 |
| 30 | 35223 | 1 | Crankshaft |
| 35 | 29826 | 1 | Screw, 10-32 x 3/4" |
| 36 | 29918 | 1 | Lock Washer |
| 37 | 29216 | 1 | Lock Nut, 10-32 |
| 38 | 29642 | 1 | Retaining Ring |
| 40 | 34531 | 1 | Piston, Pin & Ring Set (Std.) |
| 40 | 34532 | 1 | Piston, Pin & Ring Set (.010" OS) |
| 40 | 34533 | 1 | Piston, Pin & Ring Set (.020" OS) |
| 41 | 33312B | 1 | Piston & Pin Ass'y. (Std.) (Incl. 43) |
| 41 | 33313B | 1 | Piston & Pin Ass'y. (.010" OS) (Incl. 43) |
| 41 | 33314B | 1 | Piston & Pin Ass'y. (.020" OS) (Incl. 43) |
| 42 | 34854 | 1 | Ring Set (Std.) |
| 42 | 34855 | 1 | Ring Set (.010" OS) |
| 42 | 34856 | 1 | Ring Set (.020" OS) |
| 43 | 27888 | 2 | Piston Pin Retaining Ring |
| 45 | 31380C | 1 | Connecting Rod Ass'y. (Incl. 46) |
| 46 | 650662C | 2 | Connecting Rod Bolt |
| 48 | 34034 | 2 | Valve Lifter |
| 50 | 32115 | 1 | Camshaft (MCR) |
| 60 | 30622A | 1 | Blower Housing Extension |
| 65 | 650128 | 1 | Screw, 10-24 x 1/2" |
| 69 | 30684 | 1 | * Cylinder Cover Gasket |
| 70 | 31451A | 1 | Cylinder Cover (Incl. 74,75,80,175 & 176) |
| 72A | 28534 | 1 | Oil Drain Plug |
| 72 | 27642 | 2 | Oil Drain Plug |
| 75 | 28460 | 1 | Oil Seal |
| 80 | 31845 | 1 | Governor Shaft |
| 81 | 30590A | 1 | Washer |
| 82 | 30591 | 1 | Governor Gear Ass'y. (Incl. 81) |
| 83 | 30588A | 1 | Governor Spool |
| 84 | 29193 | 1 | Retaining Ring |
| 86 | 650488 | 7 | Screw, 1/4-20 x 1-1/4" |
| 87 | 650493 | 1 | Screw, 1/4-20 x 1-3/4" |
| 89 | 32589 | 1 | Flywheel Key |
| 90 | 611084 | 1 | Flywheel |
| 92 | 650815 | 1 | Belleville Washer |
| 93 | 8116 | 1 | Flywheel Nut |
| 100 | 34443A | 1 | Solid State Ignition |
| 102 | 651024 | 2 | Solid State Mounting Stud |
| 103 | 651007 | 2 | Screw, Torx T-15, 10-24 x 15/16" |
| 110 | 35183 | 1 | Ground Wire |
| 119 | 36445 | 1 | * Cylinder Head Gasket |

| Ref # | Part Number | Qty | Description |
|-------|-------------|-----|---------------------------------------|
| 120 | 36446 | 1 | Cylinder Head (Incl. 3 of 130) |
| 125 | 27878A | 1 | Exhaust Valve (Std.) (Incl. 151) |
| 125 | 27880A | 1 | Exhaust Valve (1/32" OS) (Incl. 151) |
| 126 | 32783 | 1 | Intake Valve (Std.) (Incl. 151) |
| 126 | 32784 | 1 | Intake Valve (1/32" OS) (Incl. 151) |
| 127 | 650691 | 3 | Washer |
| 128 | 650690 | 3 | Belleville Washer |
| 130 | 650697A | 8 | Screw, 5/16-18 x 2-1/2" |
| 133 | 650890 | 1 | Lock Washer |
| 134 | 30747 | 1 | Shorting Clip |
| 135 | 33636 | 1 | Resistor Spark Plug (J8C/356) |
| 139 | 31843A | 1 | Governor Gear Bracket |
| 140 | 650965 | 2 | Screw, Torx T-25, 10-24 x 1/2" |
| 149 | 27882 | 2 | Valve Spring Cap |
| 150 | 27881 | 2 | Valve Spring |
| 151 | 32581 | 2 | Valve Spring Keeper |
| 169 | 27896A | 2 | * Breather Gasket |
| 170 | 28423 | 1 | Breather Body |
| 171 | 28424 | 1 | Breather Element |
| 172 | 28425 | 1 | Valve Cover |
| 173 | 35350 | 1 | Breather Tube |
| 174 | 650128 | 2 | Screw, 10-24 x 1/2" |
| 182 | 650517 | 2 | Screw, 1/4-20 x 27/32" |
| 184 | 31688A | 1 | * Carburetor To Intake Pipe Gasket |
| 186 | 34661 | 1 | Governor Link |
| 200 | 34664 | 1 | Control Bracket (Incl. 19, 203 & 204) |
| 203 | 31342 | 1 | Compression Spring |
| 204 | 651029 | 1 | Screw, Torx T-10, 5-40 x 7/16" |
| 207 | 34662 | 1 | Throttle Link |
| 209 | 650821 | 2 | Screw, 10-32 x 1/2" |
| 210 | 27793 | 1 | Conduit Clip |
| 211 | 28942 | 1 | Screw, 10-32 x 3/8" |
| 215 | 30985 | 1 | Throttle Control |
| 224 | 27915A | 1 | * Intake Pipe Gasket |
| 238 | 28820 | 2 | Screw, 10-32 x 1/2" |
| 239 | 27272A | 1 | * Air Cleaner Gasket |
| 242 | 31691 | 1 | Air Cleaner Bracket |
| 243 | 650152 | 2 | Screw, 8-32 x 3/8" |
| 245 | 30727 | 1 | Air Cleaner Filter |
| 250 | 31715 | 1 | Air Cleaner Cover |
| 260 | 35887 | 1 | Blower Housing |
| 262 | 29747B | 2 | Screw, Torx T-40, 5/16-24 x 21/32" |
| 265 | 30939A | 1 | Cylinder Head Cover |
| 269 | 35865 | 1 | * Exhaust Gasket |
| 272 | 30196 | 2 | Screw, 5/16-18 x 3/4" |
| 273 | 34712 | 1 | Carburetor Flange |
| 275 | 32401 | 1 | Muffler |
| 277A | 30196 | 1 | Screw, 5/16-18 x 3/4" |
| 277 | 650694A | 1 | Screw, 5/16-18 x 2" |
| 279B | 26073 | 1 | Washer |
| 285 | 35287B | 1 | Starter Cup |
| 285 | 35287B | 1 | Starter Cup |
| 287 | 650926 | 3 | Screw, 8-32 x 21/64" |
| 291 | 30962 | 1 | Fuel Line |
| 292 | 26460 | 2 | Fuel Line Clamp |

| Ref # | Part Number | Qty | Description |
|-------|-------------|-----|--|
| 298 | 650665 | 2 | Screw, 1/4-15 x 3/4" |
| 300 | 34186A | 1 | Fuel Tank (Incl. 292 & 301) |
| 301 | 35355 | 1 | Fuel Cap |
| 305 | 35554 | 1 | Oil Fill Tube |
| 307 | 35499 | 1 | "O" Ring |
| 308 | 35540 | 1 | Fill Tube Clip |
| 325 | 34246 | 1 | Wire Clip |
| 340 | 34159 | 1 | Fuel Tank Bracket |
| 341 | 34158 | 1 | Fuel Tank Bracket |
| 342 | 650561 | 1 | Screw, 1/4-20 x 5/8" |
| 370 | 36261 | 1 | Identification Decal |
| 370K | 36695 | 1 | Starter Decal |
| 380 | 632230 | 1 | Carburetor (Incl. 184) |
| 390 | 590732A | 1 | Rewind Starter (Note: This engine could have been built with 590738 starter. Refer to the design of the rope pulley strength ribs for part identification. Individual starter parts do not interchange. Refer to service bulletin number 518.) |
| 400 | 36447 | 1 | * Gasket Set (Incl. items marked PK in notes) Incl. part #'s 26756 (1), 27272A (1), 27896A (2), 27915A (1), 29673 (1), 30684 (1), 31688A (1), 33629 (1), 34912 (1), 35865 (1), 36445 (1) |
| 420 | 730225 | 1 | SAE 30 4-Cycle Engine Oil (Quart) |
| 453 | 29538 | 1 | Engine Mounting Base |
| 454 | 650542 | 4 | Screw, 5/16-18 x 3/4" |

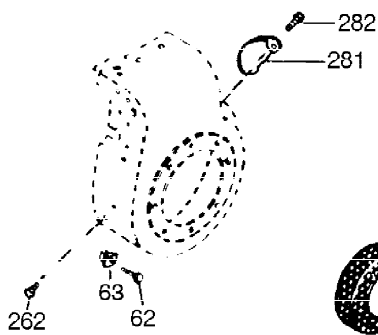
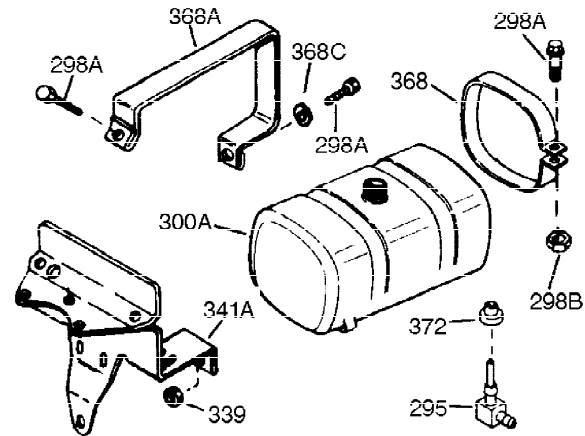
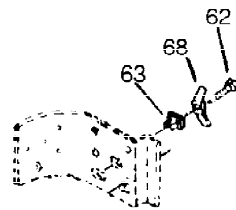
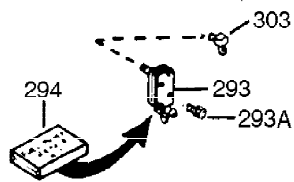

**OPTIONAL 110-120
VOLT STARTER
MOTOR KIT**

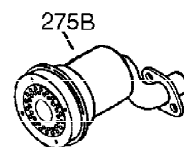
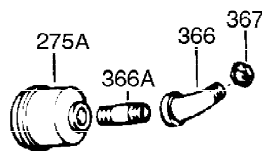
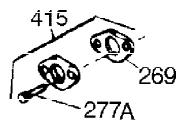
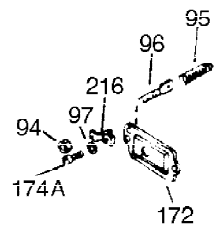
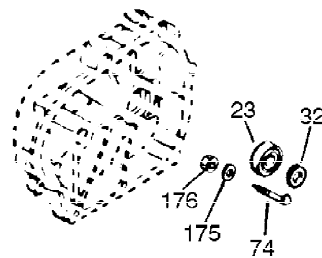
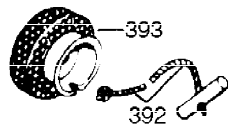
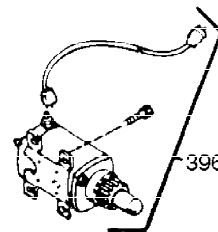

| Ref # | Part Number | Qty | Description |
|-------|-------------|-----|------------------------------------|
| 23 | 31793 | 1 | Ball Bearing |
| 32 | 31792 | 1 | Washer |
| 62 | 650760 | 1 | Screw, 8-32 x 3/8" |
| 63 | 28545 | 1 | Grommet |
| 68 | 33356 | 1 | Ground Terminal |
| 74 | 31855 | 2 | Bearing Retainer |
| 172 | 28425 | 1 | Valve Cover |
| 175 | 650778 | 2 | Lock Washer |
| 176 | 650580 | 2 | Lock Nut, 10-24 |
| 262 | 29747B | 2 | Screw, Torx T-40, 5/16-24 x 21/32" |
| 269 | 35865 | 1 | * Exhaust Gasket |
| 277A | 30196 | 1 | Screw, 5/16-18 x 3/4" |



**OPTIONAL
STARTER MUFF KIT**



730571

Can be used on H50-60 with
stamped steel starter.



| Ref # | Part Number | Qty | Description |
|-------|-------------|-----|-----------------------|
| 90 | 611084 | 1 | Flywheel |
| 239 | 27272A | 1 | * Air Cleaner Gasket |
| 242 | 31691 | 1 | Air Cleaner Bracket |
| 245 | 30727 | 1 | Air Cleaner Filter |
| 250 | 31715 | 1 | Air Cleaner Cover |
| 370G | 35274 | 1 | Oil Instruction Decal |