

ILLUSTRATION SHOWS TYPICAL PARTS ONLY. ORDER BY PART NUMBER. PARTS NOT LISTED ARE SUPPLIED BY OEM.



Ref #	Part Number	Qty	Description
1	32586C		Cylinder (Incl. 2, 3, 4 & 76) (2-3/4" Bore)
2	27652		Pin, Dowel
3	27642		Plug, Oil drain
4	32630		Seal, Oil
5	32783		Intake Valve (Std.) (Incl. 9)
5	32784		Intake Valve (1/32" OS) (Incl. 9)
6	27878A		Exhaust Valve (Std.) (Incl. 9)
6	27880A		Exhaust Valve (1/32" OS) (Incl. 9)
7A	20810		Pin, Valve spring retainer (Use as re quired)
7	27882		Cap, Upper valve spring
8	27881		Spring, Valve
8A	27881		Spring, Valve
9A	32581		Cap, Lower valve spring
9	32581		Cap, Lower valve spring
10	34242		Dipper, Oil
10A	32590		Plate, Lock & Oil dipper (This plate may be replaced by 34242 oil dipper but 650662C screw must be used.)
11	32782		Crankshaft (Incl. 12 &13)
12	29783		Crankshaft Gear Pin (Early production)
13	27884		Gear, Crankshaft (Used in early produ ction) This gear is servicable onlywhen it is pinned to the crankshaft.
14	34517		Piston, Pin & Ring Set (Std.) (2-3/4" Bore)
14	34518		Piston, Pin & Ring Set (.010" OS)
14	34519		Piston, Pin & Ring Set (.020" OS)
14A	32592B		Piston & Pin Ass'y. (Std.)(2-3/4")(In cl.16)
14A	32593B		Piston & Pin Ass'y. (.010" OS) (Incl. 16)
14A	32594B		Piston & Pin Ass'y. (.020" OS) (Incl. 16)
15	32595		Ring Set (Std.) (2-3/4" Bore)
15	32596		Ring Set (.010" OS)
15	32597		Ring Set (.020" OS)
16	27888		Ring, Piston pin retaining
17	32591C		Rod Assy., Connecting (Incl. 10 & 18)
18	650662C		Screw, Connecting rod (2 each)
21	32115		Camshaft (MCR)
22	34034		Lifter, Valve
23	31451A		Cylinder Cover (Incl.24, 106, 309, 31 0 & 311)
24B	31546		Bushing, Crankshaft (Use as required)
24	28460		Seal, Oil
25	29668		Dipstick, Oil (Incl. 30)
26	30684		* Gasket, Cylinder cover
28	650488		Screw, 1/4-20 x 1-1/4"
30	29673		* Gasket, Oil filler
31	650489		Screw, 1/4-20 x 5/8"
31	650516		Screw, 1/4-20 x 1-1/8"
32	32631A		* Gasket, Cylinder head
33	30938A		Head, Cylinder
34	27793		Clip, Conduit (Use as required)
35	28942		Screw, 10-32 x 3/8" (Use as required)
36	650697A		Screw, 5/16-18 x 2-1/2" (Use as requi red)
36	650695A		Screw, 5/16-18 x 2-1/4" (Use as requi red)
36	650694A		Screw, 5/16-18 x 2" (Use as required)
37	33636		Resistor Spark Plug (RJ-8C)

Ref #	Part Number	Qty	Description
37	34251		Resistor Spark Plug
38	27896A		* Gasket, Breather cover
39	28423		Body, Breather
40	28424		Element, Breather
41	28425		Cover, Valve spring
42	26073		Washer (Use as required)
42	650691		Washer, Flat (Use as required)
42A	650690		Washer, Belleville (Use as required)
43	650128		Screw, 10-24 x 1/2"
45	27915A		* Gasket, Intake
46	30195A		Flange, Carburetor (Incl. 79 & 80)
47	30196		Screw, 5/16-18 x 3/4"
48	29716		Screw, 1/4-28 x 7/16"
50	650548		Screw, 8-32 x 5/16"
52	32326A		Lever, Governor (New lever does not need 1 of 51,66,132,164,165,207)
55	30205		Bracket, Adjusting
56	30206		Link, Throttle
59	29216		Nut, Lock, 10-32
60	650152		Screw, 8-32 x 3/8"
61	29826		Screw, 10-32 x 3/4"
62	29642		Ring, Retaining
63	30699B		Governor Rod Ass'y. (This one-piece governor rod is no longer used. It is replaced by 30699C ass'y., Ref. no. 63A)
63A	30699C		Rod Assy., Governor (Incl. 64 & 65)
64	30700		Yoke, Governor
65	650494		Screw, 6-40 x 5/16"
66	29918		Lockwasher, #8 E.T.
67	35350		Tube, Breather
69	29747B		Screw, 5/16-24 x 21/32"
70	32158E		Blower Housing (For elec.star.)(Incl. 134,135)
71	650815		Washer, Belleville
72	8116		Nut, Hex
73	29536		Blower Housing Baffle (without electric starter knock-out) (Use as required)
73	35256A		Blower Housing Baffle (with electric starter knock-out) (Use as required) (Point Ignition)
74	650561		Screw, 1/4-20 x 5/8"
75	31688A		* Gasket, Carburetor
79	29752		Nut & Lockwasher Assy., 1/4-28
80	650572		Screw, 1/4-28 x 1-1/8"
82A	730164		Air Cleaner Ass'y. (Incl. 60, 83, 87, 88, 89, 90A & 331B) (Use as required)
83	27272A		* Gasket, Air cleaner
87	31691		Bracket, Air cleaner NOTE: 130010 thru 10C & 11 used in early production only.
88	28820		Screw, 10-32 x 1/2"
89	30727		Element, Air cleaner
90	31715		Body, Air cleaner
98	32924		Spring, Compression
99	650688		Screw, 10-32 x 1"

Ref #	Part Number	Qty	Description
100	29538		Base, Engine mounting
106	31845		Shaft, Mechanical governor
107	30591		Gear Assy., Governor (Incl. 109)
108	30588A		Spool, Governor
109	30590A		Washer, Flat
110	29193		Ring, Retaining
113	30063		Screw, 1/4-20 x 1/2"
114	31301		Fuel Tank (Incl. 115)
115	410144B		Fuel Cap (White Plastic)(Std)(As required)
115	33032		Fuel Cap (Charcoal Plastic) (Spurt resistant, Low profile) (Use as required)
115	34210		Fuel Cap (Red Plastic) (Spurt resistant, High profile) (Use as required)
115	35355		Fuel Cap (Use as required)
117A	29683		Valve, Fuel shut-off
118	29774		Fuel Line (Braided 8-1/4" 21 cm)(Use as req.)
118	30705		Fuel Line (Braided 16") (41 cm) (Use as req.)
118	30962		Fuel Line (Braided 32") (81 cm) (Use as req.)
120	650128		Screw, 10-24 x 1/2" (Use as required)
121	30622A		Extension, Blower housing
124	650542		Screw, 5/16-18 x 3/4"
127	26073		Washer (Use as required)
128	650694A		Screw, 5/16-18 x 2" (Use as required)
129	32589		Key, Flywheel
130	31843A		Bracket, Governor gear
131	650836		Screw, 10-24 x 1/2"
133	650493		Screw, 1/4-20 x 1-3/4"
149	30747		Clip, Shorting
150	650890		Lockwasher
193	610118		Cover, Spark plug (Use as required)
193	27276		Cover, Spark plug
205	650561		Screw, 1/4-20 x 5/8" (Use as required)
209	30939A		Cover, Cylinder head
246	32125		Cup, Starter
247	590417		Screen, Starter cup
266	26460		Clamp, Fuel line
270	31461		Bushing, Crankshaft (Use as required)
274	610973		Terminal Ass'y. (As req. on late production)
287	27275		Clip, Hi-tension wire (Use as required)
287	34246		Clip, Ground wire (Use as required)
331A	34346		Decal, Instruction
331B	31752		Decal, Air cleaner
331	550223		Decal, Name
332	30547A		Contact Assy., Breaker
333	30548B		Condenser
334	631021		Inlet Needle, Seat & Clip Assy.
336	631453		Carburetor (Incl. 75) (Refer to Division 5, Section A, page 100 for breakdown)

Ref #	Part Number	Qty	Description
337	610826		Magneto (w/ring gear)(12 Vt/3 Amp)(2 NOTE: The complete magneto is not available as an assembly. The magneto number is shown for reference purposes only. Order component parts individually, as show in parts list. Circuit) (Refer to Division 5, Section B, page 27 for breakdown)
338	590420		Rewind Starter (Refer to Division 5, Section C, page 25 for breakdown)
343	33239A		Gasket Set (Incl. items marked*)

ILLUSTRATION SHOWS TYPICAL PARTS ONLY. ORDER BY PART NUMBER. PARTS NOT LISTED ARE SUPPLIED BY OEM.

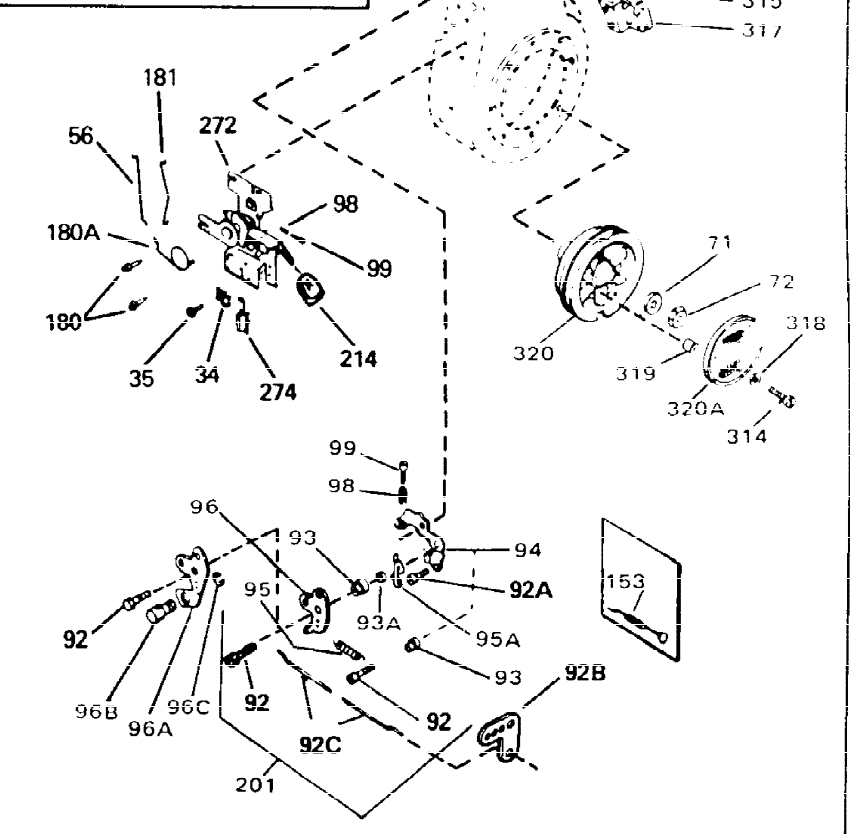
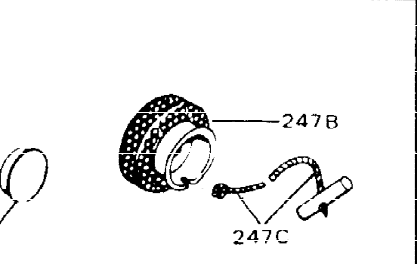
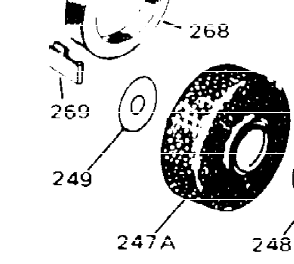
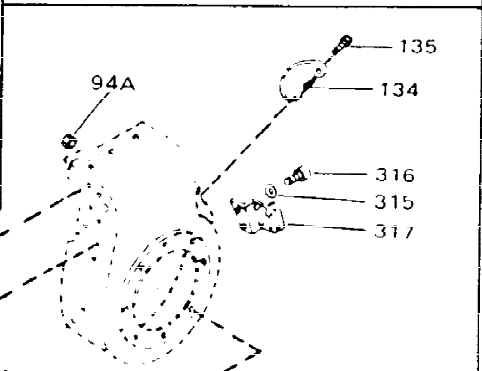
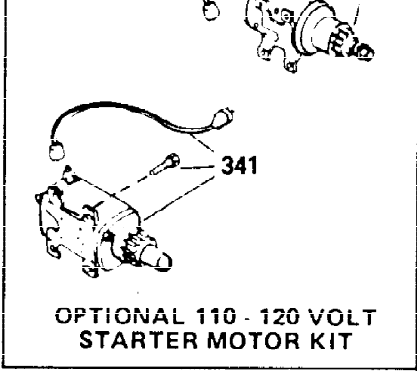
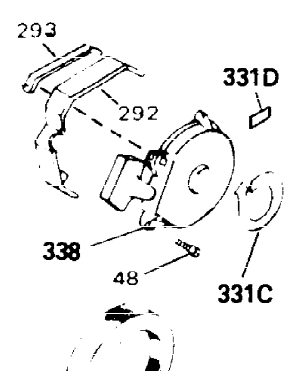
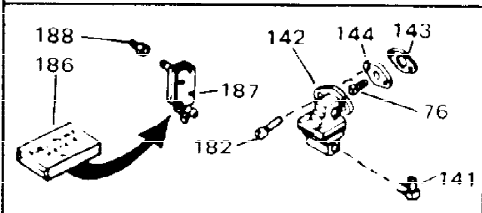
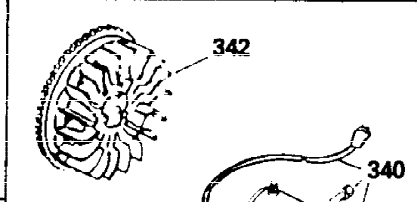
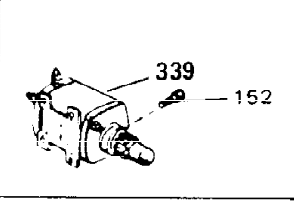

Ref #	Part Number	Qty	Description
31	650489		Screw, 1/4-20 x 5/8"
31	650516		Screw, 1/4-20 x 1-1/8"
34	27793		Clip, Conduit (Use as required)
35	28942		Screw, 10-32 x 3/8" (Use as required)
43A	650128		Screw, 10-24 x 1/2"
48	29716		Screw, 1/4-28 x 7/16"
56	30206		Link, Throttle
71	650815		Washer, Belleville
72	8116		Nut, Hex
92C	31879		Link, Governor lever-to-bellcrank
92A	650399		Screw, 10-32 x 5/8" (Supplied by OEM)
92	30312		Screw, 10-32 x 1/2"
92B	30712		Lever, Bellcrank
93	29530		Bushing, Bellcrank
93A	28562		Bushing, RPM adjusting lever
94	30199A		Bracket, Speed control (Incl. 98 & 99)
94A	33450		Nut, Lock
95	30202		Spring, Extension
95A	32977		Spring, Torsion
96	30201A		Lever, Speed control
98	32924		Spring, Compression
99	650688		Screw, 10-32 x 1"
193	610118		Cover, Spark plug (Use as required)
193	27276		Cover, Spark plug
201	730152		Control Bracket (Incl. 92, 92A, 92B,93, 93A,94, 95, 95A & 96)
263	650764		Nut, "U" Type (Use as required)
274	610973		Terminal Ass'y. (As req. on late prod uction)
308	31793		Bearing, Ball
309	31855		Retainer, Bearing
310	650778		Washer, Lock
311	650580		Nut, Lock
312	31792		Washer, Thrust
331	550223		Decal, Name
338	590420		Rewind Starter (Refer to Division 5, Section C, page 25 for breakdown)
340	33328D		Starter Motor Kit (110-120 Volt) This 110-120 volt starter motor kit may have been added to this engine. It can be added only if cylinder hasdrilled and tapped starter mounting bosses and a ring gear flywheel (see#342). Refer to service number stamped on end cap of motor, or on decal, for identifica
342	30811A		Flywheel (Ring gear flywheel requiredon engines using 110-120 volt starter kits listed above)
342	611042		Flywheel (Used on Type letters H and above) (Std. Point ignition) (Ring gear flywheel required on engines using 110-120 volt starter kits listed above)
342	611085		Flywheel (Minimum ring gear flywheel required on engines using 110-120 volt starter kits listed above) (Use withSolid State ignition)

ILLUSTRATION SHOWS TYPICAL PARTS ONLY. ORDER BY PART NUMBER. PARTS NOT LISTED ARE SUPPLIED BY OEM.



Ref #	Part Number	Qty	Description
27	27513		Lockwasher, 1/4" (Use as required)
36	650697A		Screw, 5/16-18 x 2-1/2" (Use as requi red)
36	650695A		Screw, 5/16-18 x 2-1/4" (Use as requi red)
36	650694A		Screw, 5/16-18 x 2" (Use as required)
38	27896A		* Gasket, Breather cover
42	26073		Washer (Use as required)
42	650691		Washer, Flat (Use as required)
50	650548		Screw, 8-32 x 5/16"
51	30319		Rivet, Split (Used in early productio n)
52	32326A		Lever, Governor (New lever does not need 1 of 51,66,132,164,165,207)
55	30205		Bracket, Adjusting
57	730130		Exh.Adap.Kit (Incl. 58 & 125) (Use as req.)
58	30196		Screw, 5/16-18 x 3/4" (Use as require d)
59	29216		Nut, Lock, 10-32
61	29826		Screw, 10-32 x 3/4"
66	29918		Lockwasher, #8 E.T.
82B	730561		Air cleaner kit (Incl. 38, 67A, 83, 84B, 85,89B, 89C, 90A, 91, 91A, 91B, 91C, 91D, 245 & 331B) (Use only on engines with an externally vented fully adjustable carburetor)
82	730127		Air Cleaner Ass'y. (Incl. 60, 83, 87, 88, 89A, 90, 238 & 331B) (Use as required)
83	27272A		* Gasket, Air cleaner
84D	34819		Air Cleaner Elbow (Incl. 84B, 86A, 91, 91A, 91B & 91C) (Use in 730561 assembly only)
88	28820		Screw, 10-32 x 1/2"
90	31715		Body, Air cleaner
101	32394		Muffler Elbow
102	30244		Muffler Nipple
103E	391026		Opt. Spark Arrest Muffler (Incl.196,1 97,199)
103C	32985		Muffler
104	28443		Conduit Nut
104	32862		Conduit Nut
113	30063		Screw, 1/4-20 x 1/2"
118	29774		Fuel Line (Braided 8-1/4" 21 cm)(Use as req.)
118	30705		Fuel Line (Braided 16") (41 cm) (Use as req.)
118	30962		Fuel Line (Braided 32") (81 cm) (Use as req.)
128	650694A		Screw, 5/16-18 x 2" (Use as required)
132	650548		Screw, 8-32 x 5/16" (Early production)
148	34067		Wire Assy., Alternator adapter (4-1/4 ")
148	34069		Wire Assy., Alternator adapter (6-3/4 ")
189	6201		Screw, 1/4-28 x 7/8"
202	31288		Exh. Adaptor Kit (Incl.125,203,204) (As req.)
203	650697A		Screw, 5/16-18 x 2-1/2" (Use as requi red)
204	6021A		Screw, 5/16-18 x 1-1/2" (Use as requi red)
262	29752		Nut, Lock
266	26460		Clamp, Fuel line
276	31697		Strap, Fuel tank
277	29212		Screw, Hex hd. Sems, 1/4-28 x 7/16
331B	31752		Decal, Air cleaner