

ILLUSTRATION SHOWS TYPICAL PARTS ONLY. ORDER BY PART NUMBER. PARTS NOT LISTED ARE SUPPLIED BY OEM.



Ref #	Part Number	Qty	Description
1	32586C		Cylinder (Incl. 2, 3, 4 & 76) (2-3/4" Bore)
2	27652		Pin, Dowel
3	27642		Plug, Oil drain
4	32630		Seal, Oil
5	32783		Intake Valve (Std.) (Incl. 9)
5	32784		Intake Valve (1/32" OS) (Incl. 9)
6	27878A		Exhaust Valve (Std.) (Incl. 9)
6	27880A		Exhaust Valve (1/32" OS) (Incl. 9)
7	27882		Cap, Upper valve spring
7A	20810		Pin, Valve spring retainer (Use as re quired)
8A	27881		Spring, Valve
8	27881		Spring, Valve
9	32581		Cap, Lower valve spring
9A	32581		Cap, Lower valve spring
10	34242		Dipper, Oil
10A	32590		Plate, Lock & Oil dipper (This plate may be replaced by 34242 oil dipper but 650662C screw must be used.)
11	32680A		Crankshaft (Incl. 12 & 13)
12	29783		Crankshaft Gear Pin (Early production)
13	27884		Gear, Crankshaft (Used in early produ ction) This gear is servicable onlywhen it is pinned to the crankshaft.
14	34517		Piston, Pin & Ring Set (Std.) (2-3/4" Bore)
14	34518		Piston, Pin & Ring Set (.010" OS)
14	34519		Piston, Pin & Ring Set (.020" OS)
14A	32592B		Piston & Pin Ass'y. (Std.)(2-3/4")(In cl.16)
14A	32593B		Piston & Pin Ass'y. (.010" OS) (Incl. 16)
14A	32594B		Piston & Pin Ass'y. (.020" OS) (Incl. 16)
15	32595		Ring Set (Std.) (2-3/4" Bore)
15	32596		Ring Set (.010" OS)
15	32597		Ring Set (.020" OS)
16	27888		Ring, Piston pin retaining
17	32591C		Rod Assy., Connecting (Incl. 10 & 18)
18	650662C		Screw, Connecting rod (2 each)
19	30968		Nipple, Oil drain
20	30969		Cap, Oil drain
21	32115		Camshaft (MCR)
22	34034		Lifter, Valve
23	31303B		Cover, Cylinder (Incl. 24, 106 & 279)
24	28427		Seal, Oil
24B	31546		Bushing, Crankshaft (Use as required)
25A	33893A		Tube, Oil filler
25	34011A		Dipstick, Oil (Incl. 30)
26	30684		* Gasket, Cylinder cover
28	650488		Screw, 1/4-20 x 1-1/4"
30	33590		"O" Ring
31	650489		Screw, 1/4-20 x 5/8"
32	32631A		* Gasket, Cylinder head
33	30938A		Head, Cylinder
34	27793		Clip, Conduit (Use as required)
35	28942		Screw, 10-32 x 3/8" (Use as required)
36	650697A		Screw, 5/16-18 x 2-1/2" (Use as requi red)
36	650695A		Screw, 5/16-18 x 2-1/4" (Use as requi red)

Ref #	Part Number	Qty	Description
36	650694A		Screw, 5/16-18 x 2" (Use as required)
37	33636		Resistor Spark Plug (RJ-8C)
37	34251		Resistor Spark Plug
38	27896A		* Gasket, Breather cover
39	28423		Body, Breather
40	28424		Element, Breather
41	28425		Cover, Valve spring
42A	650690		Washer, Belleville (Use as required)
42	26073		Washer (Use as required)
42	650691		Washer, Flat (Use as required)
43	650128		Screw, 10-24 x 1/2"
45	27915A		* Gasket, Intake
46	34712		Flange Carburetor
47	30196		Screw, 5/16-18 x 3/4"
48	29716		Screw, 1/4-28 x 7/16"
50	650548		Screw, 8-32 x 5/16"
52	33454		Lever Assy., Governor
56	34662		Link, Throttle
59	29216		Nut, Lock, 10-32
61	29826		Screw, 10-32 x 3/4"
62	29642		Ring, Retaining
63	30699B		Governor Rod Ass'y. (This one-piece governor rod is no longer used. It is replaced by 30699C ass'y., Ref. no. 63A)
63A	30699C		Rod Assy., Governor (Incl. 64 & 65)
64	30700		Yoke, Governor
65	650494		Screw, 6-40 x 5/16"
66	29918		Lockwasher, #8 E.T.
67	35350		Tube, Breather
69	29747B		Screw, 5/16-24 x 21/32"
70	35260		Blower Housing (For electric starter)
71	650815		Washer, Belleville
72	8116		Nut, Hex
73	29536		Blower Housing Baffle (without electric starter knock-out) (Use as required)
73	35256A		Blower Housing Baffle (with electric starter knock-out) (Use as required) (Point Ignition)
74	650561		Screw, 1/4-20 x 5/8"
75	31688A		* Gasket, Carburetor
80A	650517		Screw, 1/4-20 x 27/32"
82A	730164		Air Cleaner Ass'y. (Incl. 60, 83, 87, 88, 89, 90A & 331B) (Use as required)
97	34240		Ground Wire
98	31342		Spring, Compression
99	650549		Screw, 5-40 x 7/16"
100	29538		Base, Engine mounting
103	32401		Muffler
106	31845		Shaft, Mechanical governor
107	30591		Gear Assy., Governor (Incl. 109)
108	30588A		Spool, Governor
109	30590A		Washer, Flat
110	29193		Ring, Retaining
111C	34158		Bracket, Fuel tank

Ref #	Part Number	Qty	Description
113	650561		Screw, 1/4-20 x 5/8"
114	34186A		Fuel Tank (Incl. 115 & 266) NOTE: These tanks were built with different size fuel inlet openings. Tanks with the 1-3/16" I.D. opening use fuel cap 33032 or 34210. Tanks with the 1-1/2" I.D. opening use fuel cap 35355 or 35650.
115	410144B		Fuel Cap (White Plastic)(Std)(As required)
115	33032		Fuel Cap (Charcoal Plastic) (Spurt resistant, Low profile) (Use as required)
115	34210		Fuel Cap (Red Plastic) (Spurt resistant, High profile) (Use as required)
115	35355		Fuel Cap (Use as required)
116D	34159		Plate, Fuel tank mounting
117A	32961		Valve, Shut-off
118	29774		Fuel Line (Braided 8-1/4" 21 cm)(Use as req.)
118	30705		Fuel Line (Braided 16") (41 cm) (Use as req.)
118	30962		Fuel Line (Braided 32") (81 cm) (Use as req.)
120	650128		Screw, 10-24 x 1/2" (Use as required)
121	30622A		Extension, Blower housing
124	650542		Screw, 5/16-18 x 3/4"
125	27930A		Gasket, Exhaust
126	30196		Screw, 5/16-18 x 3/4"
127	26073		Washer (Use as required)
128	650694A		Screw, 5/16-18 x 2" (Use as required)
129	32589		Key, Flywheel
130	31843A		Bracket, Governor gear
131	650836		Screw, 10-24 x 1/2"
133	650493		Screw, 1/4-20 x 1-3/4"
149	30747		Clip, Shorting
151	650665		Screw, 1/4-15 x 7/8"
193	610118		Cover, Spark plug (Use as required)
205	650561		Screw, 1/4-20 x 5/8" (Use as required)
209	30939A		Cover, Cylinder head
219	34814		Primer Assy.
223	32180C		Line, Primer
225	34126		Bracket, Grommet mounting
226	650760		Screw, 8-32 x 3/8"
227	28545		Grommet
246	32125		Cup, Starter
247	590417		Screen, Starter cup
266	26460		Clamp, Fuel line
270	31461		Bushing, Crankshaft (Use as required)
271	33876		Gasket, Stator
274	610973		Terminal Ass'y. (As req. on late production)
287	27275		Clip, Hi-tension wire (Use as required)
287	34246		Clip, Ground wire (Use as required)
331	550223		Decal, Name
331A	34346		Decal, Instruction
332	30547A		Contact Assy., Breaker
333	30548B		Condenser
334	631021		Inlet Needle, Seat & Clip Assy.
336	631920		Carburetor (Incl. 75) (Refer to Division 5, Section A, page 138 for breakdown)

Ref #	Part Number	Qty	Description
337	610694A		Magneto (w/ring gear for 110 volt starter) NOTE: The complete magneto is not available as an assembly. The magneto number is shown for reference purposes only. Order component parts individually, as show in parts list. (Refer to Division 5, Section B, page 24 for breakdown)
338	590473		Rewind Starter (Refer to Division 5, Section C, page 29 for breakdown)
343	33239A		Gasket Set (Incl. items marked*)

ILLUSTRATION SHOWS TYPICAL PARTS ONLY. ORDER BY PART NUMBER. PARTS NOT LISTED ARE SUPPLIED BY OEM.

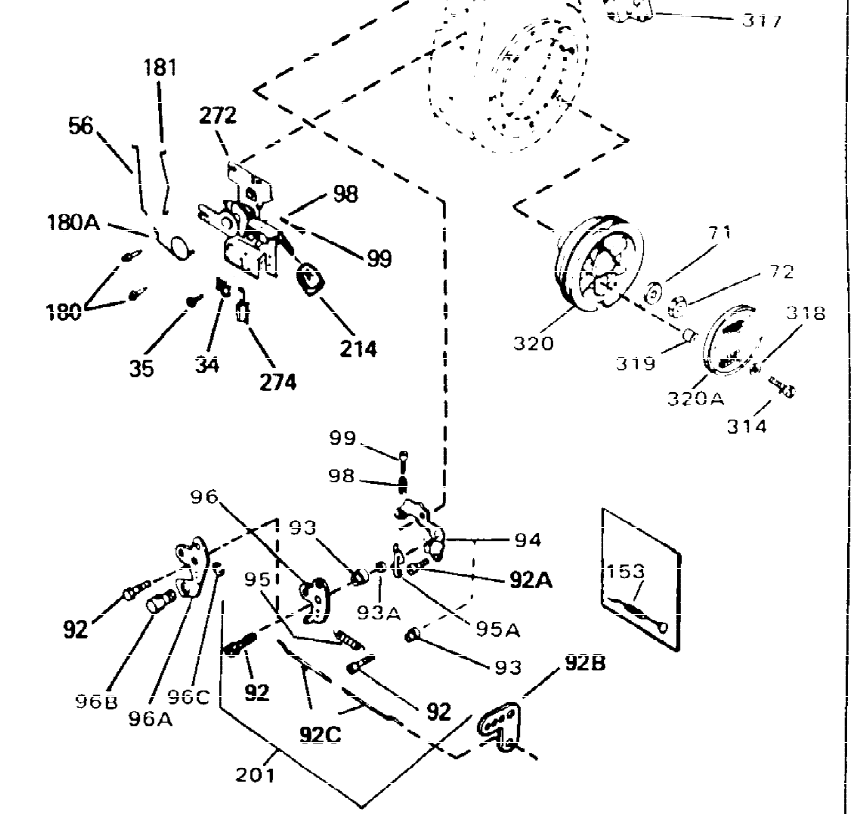
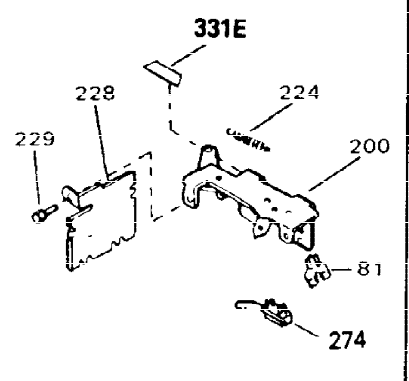
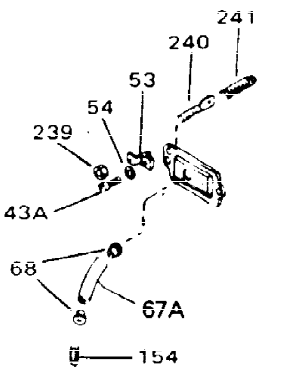
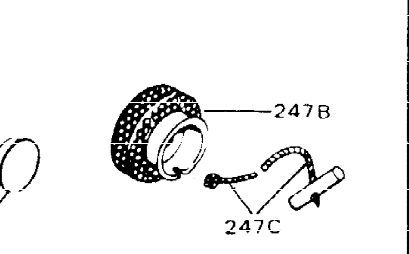
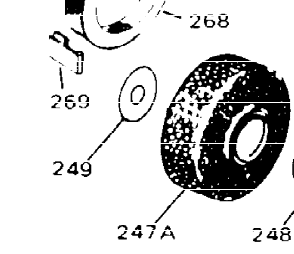
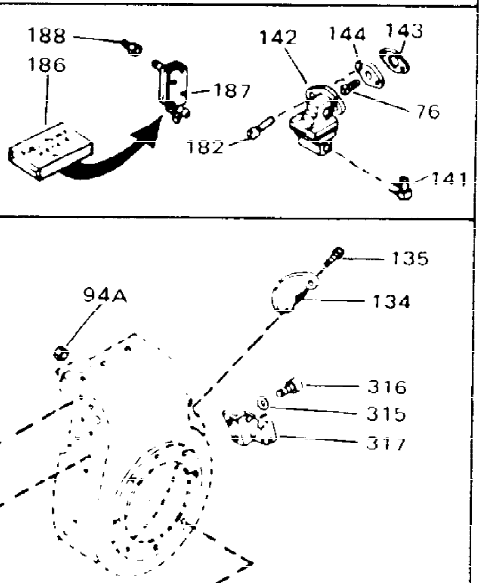
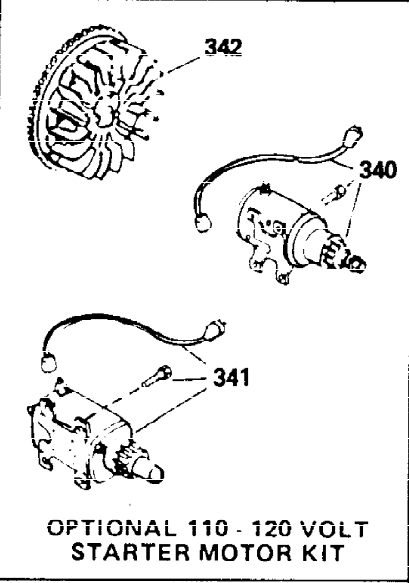
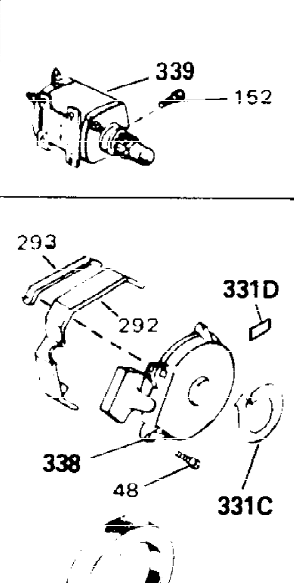
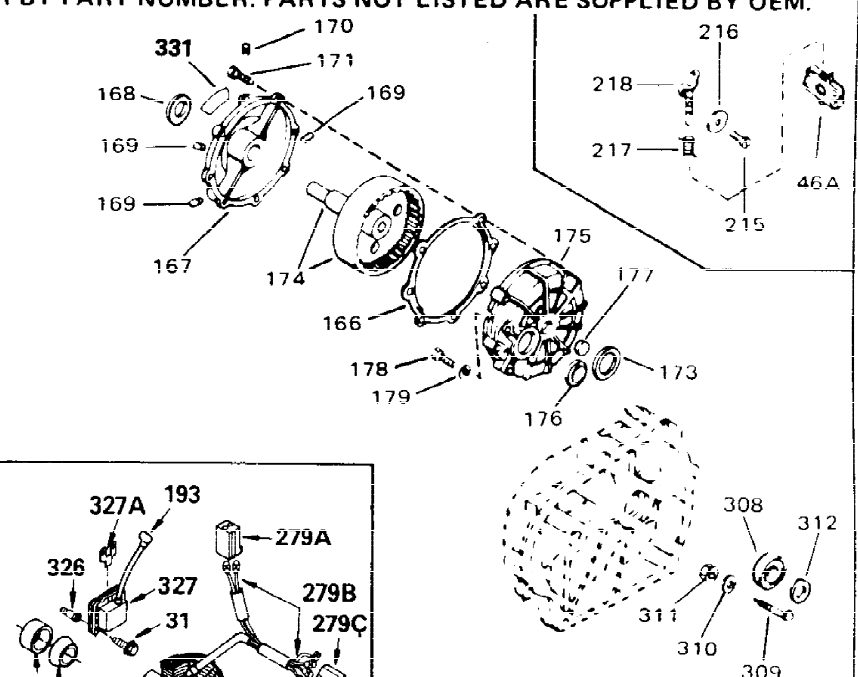

Ref #	Part Number	Qty	Description
31	650489		Screw, 1/4-20 x 5/8"
34	27793		Clip, Conduit (Use as required)
35	28942		Screw, 10-32 x 3/8" (Use as required)
43A	650128		Screw, 10-24 x 1/2"
48	29716		Screw, 1/4-28 x 7/16"
56	34662		Link, Throttle
71	650815		Washer, Belleville
72	8116		Nut, Hex
98	31342		Spring, Compression
99	650549		Screw, 5-40 x 7/16"
134	33013		Cover, Bubble
135	650760		Screw, 8-32 x 3/8"
180A	34663		Spring, Speed control
180	650821		Screw, 10-32 x 1/2"
181	34661		Link, Governor
193	610118		Cover, Spark plug (Use as required)
214A	35438		Knob, Control
223	32180C		Line, Primer
224	30826		Spring, Extension
230	650257		Screw, 8-32 x 5/16"
231	34672		Cover, Carburetor
254	32398		Bracket, Choke
255	28820		Screw, 10-32 x 1/2"
256A	650765		Screw, 10-32 x 1/2"
256	650760		Screw, 8-32 x 3/8"
263	650764		Nut, "U" Type (Use as required)
272	34664		Control Bracket (Incl. 98, 99, 180A & 274)
274	610973		Terminal Ass'y. (As req. on late prod uction)
292	34127		Guard Starter
293	32576		Seal, Snow guard
331H	34414		Decal, Warning
331E	34144		Decal, Primer
331G	34416		Decal, Choke
331	550223		Decal, Name
338	590473		Rewind Starter (Refer to Division 5, Section C, page 29 for breakdown)
340	33328D		Starter Motor Kit (110-120 Volt) This 110-120 volt starter motor kit may have been added to this engine. It can be added only if cylinder has drilled and tapped starter mounting bosses and a ring gear flywheel (see#342). Refer to service number stamped on end cap of motor, or on decal, for identifica
342	30811A		Flywheel (Ring gear flywheel required on engines using 110-120 volt starter kits listed above)
342	611042		Flywheel (Used on Type letters H and above) (Std. Point ignition) (Ring gear flywheel required on engines using 110-120 volt starter kits listed above)
342	611085		Flywheel (Minimum ring gear flywheel required on engines using 110-120 volt starter kits listed above) (Use with Solid State ignition)

ILLUSTRATION SHOWS TYPICAL PARTS ONLY. ORDER BY PART NUMBER. PARTS NOT LISTED ARE SUPPLIED BY OEM.



Ref #	Part Number	Qty	Description
27	27513		Lockwasher, 1/4" (Use as required)
36	650697A		Screw, 5/16-18 x 2-1/2" (Use as required)
36	650695A		Screw, 5/16-18 x 2-1/4" (Use as required)
36	650694A		Screw, 5/16-18 x 2" (Use as required)
38	27896A		* Gasket, Breather cover
42	26073		Washer (Use as required)
42	650691		Washer, Flat (Use as required)
50	650548		Screw, 8-32 x 5/16"
51	30319		Rivet, Split (Used in early production)
52	33454		Lever Assy., Governor
57	730130		Exh.Adap.Kit (Incl. 58 & 125) (Use as required)
58	30196		Screw, 5/16-18 x 3/4" (Use as required)
59	29216		Nut, Lock, 10-32
61	29826		Screw, 10-32 x 3/4"
66	29918		Lockwasher, #8 E.T.
82B	730561		Air cleaner kit (Incl. 38, 67A, 83, 84B, 85, 89B, 89C, 90A, 91, 91A, 91B, 91C, 91D, 245 & 331B) (Use only on engines with an externally vented fully adjustable carburetor)
82	730127		Air Cleaner Ass'y. (Incl. 60, 83, 87, 88, 89A, 90, 238 & 331B) (Use as required)
84D	34819		Air Cleaner Elbow (Incl. 84B, 86A, 91, 91A, 91B & 91C) (Use in 730561 assembly only) NOTE: 130010 thru 10C & 11 used in early production only.
103E	391026		Opt. Spark Arrest Muffler (Incl. 196, 197, 199)
113	650561		Screw, 1/4-20 x 5/8"
118	29774		Fuel Line (Braided 8-1/4" 21 cm)(Use as required)
118	30705		Fuel Line (Braided 16") (41 cm) (Use as required)
118	30962		Fuel Line (Braided 32") (81 cm) (Use as required)
125	27930A		Gasket, Exhaust
126	30196		Screw, 5/16-18 x 3/4"
128	650694A		Screw, 5/16-18 x 2" (Use as required)
132	650548		Screw, 8-32 x 5/16" (Early production)
148	34067		Wire Assy., Alternator adapter (4-1/4")
148	34069		Wire Assy., Alternator adapter (6-3/4")
164	30322		Nut & Lockwasher (Early Prod. Only)
165	29916		Clamp, Governor lever (Early Prod. Only)
202	31288		Exh. Adaptor Kit (Incl. 125, 203, 204) (As required)
203	650697A		Screw, 5/16-18 x 2-1/2" (Use as required)
204	6021A		Screw, 5/16-18 x 1-1/2" (Use as required)
226	650760		Screw, 8-32 x 3/8"
227	28545		Grommet
266	26460		Clamp, Fuel line