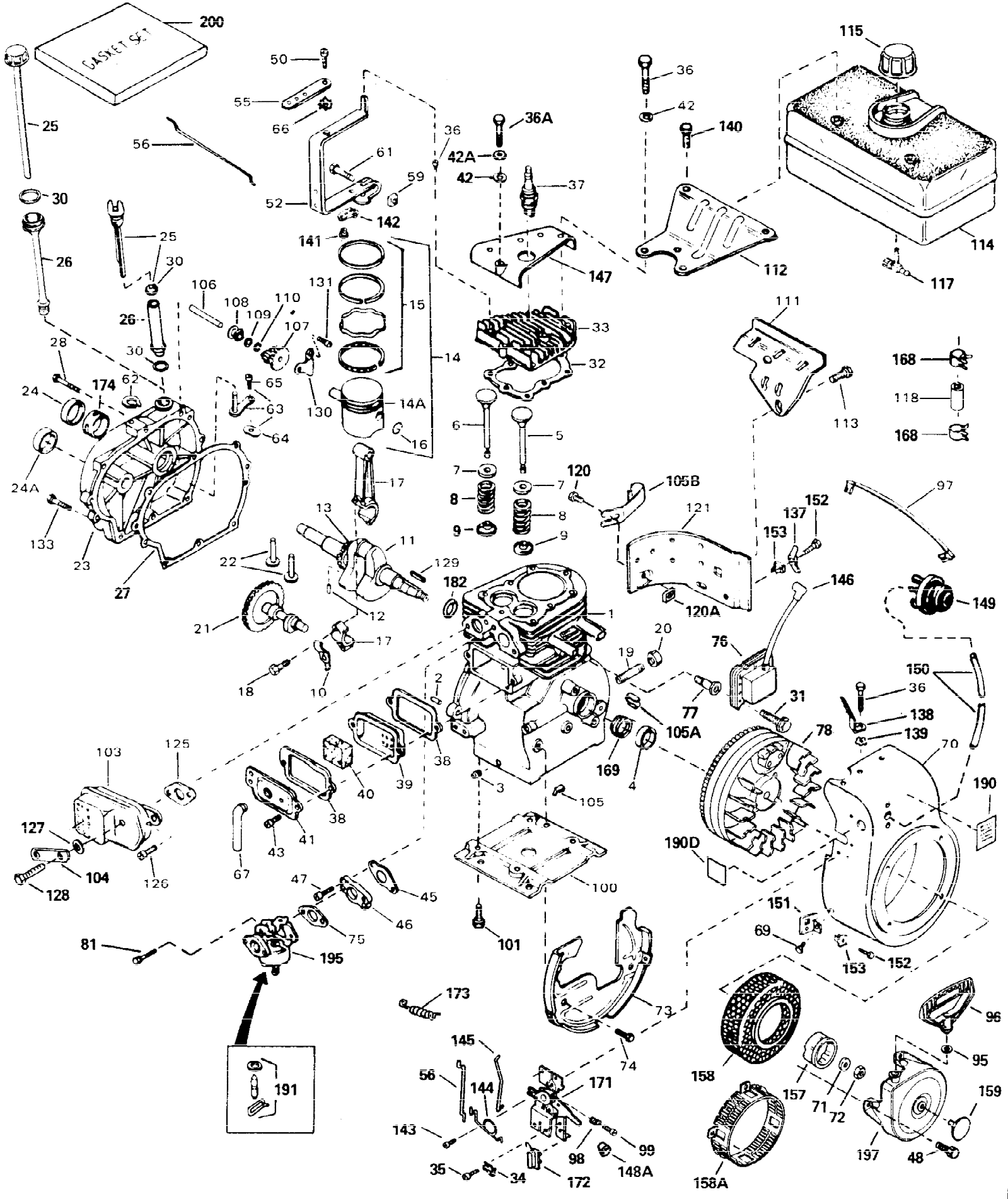

ILLUSTRATION SHOWS TYPICAL PARTS ONLY. ORDER BY PART NUMBER. PARTS NOT LISTED ARE SUPPLIED BY OEM.



Ref #	Part Number	Qty	Description
1	32586C		Cylinder (Incl. 2, 3 & 4) (2-3/4" Bore)
2	27652		Pin, Dowel
3	27642		Plug, Oil drain
4	32630		Seal, Oil
5	32783		Intake Valve (Std.) (Incl. 9)
5	32784		Intake Valve (1/32" OS) (Incl. 9)
7	27882		Cap, Upper valve spring
8	27881		Spring, Valve
9	32581		Cap, Lower valve spring
10	34242		Dipper, Oil
11	35272		Crankshaft
12	29783		Crankshaft Gear Pin (Used on early prod.)
13	27884		Gear, Crankshaft (Used on early production)
14A	32592B		Piston & Pin Ass'y. (Std.)(2-3/4")(Incl.16)
14A	32593B		Piston & Pin Ass'y. (.010" OS) (Incl. 16)
14A	32594B		Piston & Pin Ass'y. (.020" OS) (Incl. 16)
14	34517		Piston, Pin & Ring Set (Std.) (2-3/4" Bore)
14	34518		Piston, Pin & Ring Set (.010" OS)
14	34519		Piston, Pin & Ring Set (.020" OS)
15	32595		Ring Set (Std.) (2-3/4" Bore)
15	32596		Ring Set (.010" OS)
15	32597		Ring Set (.020" OS)
16	27888		Ring, Piston pin retaining
17	32591C		Rod Assy., Connecting (Incl. 10 & 18)
18	650662C		Bolt, Connecting rod (2 each)
19	30968		Nipple, Pipe
20	30969		Cap, Oil drain
21	33931		Camshaft (MCR) (Extended)
22	34034		Lifter, Valve
23	31720A		Cover, Cylinder (Incl. 24, 24A & 106)
24A	28926		Seal, Oil
24	28427		Seal, Oil
25	35555		Dipstick
26	35554		Tube, Oil filler
27	30684		* Gasket, Cylinder cover
28	650488		Screw, 1/4-20 x 1-1/4"
30	35499		"O" Ring
31	650814		Screw, Torx T-15, 10-24 x 1"
32	32631A		* Gasket, Cylinder head
33	30938A		Head, Cylinder
34	27793		Clip, Conduit (Use as required)
35	28942		Screw, 10-32 x 3/8" (Use as required)
36	650697A		Screw, 5/16-18 x 2-1/2" (Use as required)
36	650695A		Screw, 5/16-18 x 2-1/4" (Use as required)
36	650694A		Screw, 5/16-18 x 2" (Use as required)
37	33636		Resistor Spark Plug (RJ-8C)
38	27896A		* Gasket, Breather
39	28423		Body, Breather
40	28424		Element, Breather
41	28425		Cover, Valve spring
42	650691		Washer, Flat (Use as required)
42A	650690		Washer, Belleville (Use as required)
43	650128		Screw, 10-24 x 1/2"
45	27915A		* Gasket, Intake
46	34712		Flange, Carburetor

Ref #	Part Number	Qty	Description
47	30196		Screw, 5/16-18 x 3/4"
48	29716		Screw, 1/4-28 x 7/16"
50	650548		Screw, 8-32 x 5/16"
52	33454		Lever Assy., Governor
56	34662		Link, Throttle
57	730130		Exhaust Adaptor Kit (Incl.58,125) (As req.)
58	30196		Screw, 5/16-18 x 3/4" (Use as require d)
59	29216		Locknut, 10-32
61	29826		Screw, 10-32 x 3/4"
62	29642		Ring, Retaining
63	30699C		Rod, Governor (Incl. 64 & 65)
64	30700		Yoke, Governor
65	650494		Screw, 6-40 x 5/16"
66	29918		Washer, Lock #8 E.T.
67	35350		Tube, Breather
69	29747B		Screw, 5/16-24 x 21/32"
70	35260		Blower Housing (For elec.strt.)(Incl. 134,135)
71	650815		Washer, Belleville
72	650871		Nut, Hex
73	29536		Blower Housing Baffle (Without electric starter knock-out) (Use as required)
73	35256A		Blower Housing Baffle (With electric starter knock-out) (Use as required)
73	35326		Baffle, Blower housing
74	650561		Screw, 1/4-20 x 5/8"
75	31688A		* Gasket, Carburetor
76	34443A		Solid State Assy. (Incl. 146)
77	650872		Stud, Solid state mounting
78	611085		Flywheel (w/ring gear)
81	650517		Screw, 1/4-20 x 27/32"
82	730561		Air Cleaner Kit (Incl. 38, 67A, 68, 83, 84A,85, 87, 88, 89, 156 & 190A) (Use only on engines with an externally vented fully adjustable carburetor)
84A	34819		Elbow Assy., Air cleaner (Incl. 84, 90, 91, 92 & 92A)(Use in 730561 assy. only)
95	650168		Washer, Flat
96	590574		Handle, Mitten grip
97	35253		Wire Assy., Ground
98	31342		Spring, Compression
99	650549		Screw, 5-40 x 7/16"
100	29538		Base, Engine mounting
101	650542		Screw, 5/16-18 x 3/4"
103A	391026		Muffler (Incl. 183, 184 & 185) (Thisspark arrester muffler can be used on any model)
103	34185A		Muffler
104	31588		Plate, Muffler locking
105	34246		Clip, Ground wire (Use as required)
105A	29443		Clip, Fuel line
105B	35540		Clip, Fill tube
106	31845		Shaft, Mechanical governor
107	30591		Gear Assy., Governor
108	30588A		Spool, Governor
109	35479		Washer, Flat

Ref #	Part Number	Qty	Description
110	29193		Ring, Retaining
111	34158		Bracket, Fuel tank mounting
113	650561		Screw, 1/4-20 x 5/8"
114	34186A		Fuel Tank (Incl. 115 & 168) NOTE: These tanks were built with different size fuel inlet openings. Tanks with the 1-3/16" I.D. opening use fuel cap 33032 or 34210. Tanks with the 1-1/2" I.D. opening use fuel cap 35355.
115	410144B		Fuel Cap (White Plastic) (Std)(Use as req.)
115	33032		Fuel Cap (Red Plastic) (Spurt Resistant, Low Profile) (Use as required)
115	34210		Fuel Cap (Red Plastic) (Spurt Resistant, High Profile) (Use as required)
115	35355		Fuel Cap (Red Plastic) (Use as required)
118	29774		Fuel Line (Braided 8-1/4")(21 cm)(As req.)
118	30962		Fuel Line (Braided 32")(81 cm)(Use as req.)
120	650128		Screw, 10-24 x 1/2"
120A	650764		Nut, "U" Type
121	30622A		Extension, Blower housing
126	650729		Screw, 5/16-18 x 3-3/16"
129	32589		Key, Flywheel
130	31843A		Bracket, Governor gear
131	650836		Screw, 10-24 x 1/2"
133	650493		Screw, 1/4-20 x 1-3/4"
134	33013		Cover, Starter bubble
135	650760		Screw, 8-32 x 3/8"
140	650665		Screw, 1/4-15 x 7/8"
141	30322		Locknut, 8-32
142	29916		Clamp, Governor lever
143	650821		Screw, 10-32 x 1/2"
144	34663		Spring, Speed control
145	34661		Link, Governor
146	610118		Cover, Spark plug (Use as required)
147	30939A		Cover Assy., Cylinder
148A	35440		Knob, Control
148	35439		Knob, Control
149	570682		Primer Assy.
150	32180C		Line, Primer
151	34126		Bracket, Grommet mounting
152	650760		Screw, 8-32 x 3/8"
153	28545		Grommet, Plastic
154	650257		Screw, 8-32 x 5/16"
155	35060		Cover, Carburetor
157	32125		Cup, Starter
158A	35354		Screen, Starter (Stationary)
159	35392		Plug, Starter
160	610973		Terminal Assy.
161	35305		Wire Assy., Ground
162	35062		Key, Ignition
163	32398		Bracket, Choke
164	28820		Screw, 10-32 x 1/2"
165	650760		Screw, 8-32 x 3/8"
166	650765		Screw, 10-32 x 1/2"
168	26460		Clamp, Fuel line (Use as required)

Ref #	Part Number	Qty	Description
171	34677		Control Bracket (Incl. 98, 99, 144 & 172)
172	610973		Terminal Assy. (Use as required)
174	31546		Bushing, Crankshaft
175	34127		Guard, Starter
176	32576		Seal, Snow guard
183	33323		Screen, Muffler (Use as required)
184	650578		Screw, 8-18 x 3/8" (Use as required)
185	33700		Cover & Tube, Muffler (Use as require d)
188A	32203		Air Cleaner, Starter Can be used on H70 with stamped steel starter
188B	32204		Bracket, Starter air cleaner Can be used on H70 with stamped steel starter
188C	34870		Decal, Instruction Can be used on H70 with stamped steel starter
188	730571		Starter Muff Kit (Incl.188A,188B & 18 8C) Can be used on H70 with stamped steel starter
190D	34346		Decal, Instruction
190C	34418		Decal, Choke
190C	34414		Decal, Warning
190	550223		Decal, Name
190	34144		Decal, Primer
190B	35063		Decal, Instruction
191	631021		Inlet Needle, Seat & Clip Assy.
195	632371		Carburetor (Incl. 75) (Refer to Division 5, Section A, page 198 for breakdown)
197	590604		Rewind Starter (Refer to Division 5, Section C, page 29 for breakdown)
199	611042		Flywheel (Ring gear flywheel requiredon engines using 110-120 volt starter kits listed above) (For use with Std. point ignition)
199	611085		Flywheel (Ring gear flywheel requiredon engines using 110-120 volt starter kits listed above) (For use with solid state ignition)
200	33239A		Gasket Set (Incl. items marked*)