

ILLUSTRATION SHOWS TYPICAL PARTS ONLY. ORDER BY PART NUMBER. PARTS NOT LISTED ARE SUPPLIED BY OEM.

VIEW 1 of 3



Ref #	Part Number	Qty	Description
1	33039		Cylinder (Incl.2,4,30,47,119) (3-5/16 ")
2	27652		Pin, Dowel
4	31950		Seal, Oil
5	31940		Intake Valve (Std.)
5	31941		Intake Valve (1/32" OS) (Incl. 9)
6	31942		Exhaust Valve (Std.)
6	31943		Exhaust Valve (1/32" OS) (Incl. 9)
7	650592		Key, Flywheel
8	31944		Spring, Valve
9	31946		Cap, Lower valve spring (1/32" OS)
9	31945		Cap, Lower valve spring (Std.)
9A	31945		Cap, Lower valve spring (Std.)
9A	31946		Cap, Lower valve spring (1/32" OS)
10	20810		Pin, Valve spring retainer
11	33960A		Crankshaft (Incl. 12, 13, 78 & 79)
12	29783		Pin, Crankshaft gear
13	31931		Gear, Crankshaft
14	34508		Piston, Pin & Ring Set (Std.) (3-5/16 " Bore)
14	34509		Piston, Pin & Ring Set (.010" OS)
14	34510		Piston, Pin & Ring Set (.020" OS)
14	34850		Piston, Pin & Ring Set (.030" OS)
14	34523		Piston, Pin & Ring Set (.040" OS)
14	32620B		Piston & Pin Ass'y. (.040" OS) (Incl. 16)
14A	32001C		Piston & Pin Ass'y. (Std.)(Incl.16)(3 -5/16")
14A	32002B		Piston & Pin Ass'y. (.010" OS) (Incl. 16)
14A	32003B		Piston & Pin Ass'y. (.020" OS) (Incl. 16)
14A	32619B		Piston & Pin Ass'y. (.030" OS) (Incl. 16)
15	32004		Ring Set (Std.) (3-5/16" Bore)
15	32005		Ring Set (.010" OS)
15	32006		Ring Set (.020" OS)
15	32623		Ring Set (.030" OS)
15	32624		Ring Set (.040" OS)
15	32321		Re-Ringing Set, Piston
16	31919		Ring, Piston pin retaining
17	33093A		Connecting Rod Ass'y.(Std.)(Incl.18, 19 & 20)
17	34383		Connecting Rod Assy.(.010" US)(Incl.1 8,19,20)
17	34384		Connecting Rod Assy.(.020" US)(Incl.1 8,19,20)
18	32077		Bolt, Connecting rod
19	26073		Washer, Connecting rod
20	28264		Nut Assy., Lock
21	32150		Camshaft (MCR)
22	31939		Lifter, Valve
23	32816		Cylinder Cover (Incl.4,25,26A,28,30,3 4 & 43)
23A	31956A		* Gasket, Cylinder cover
25A	29673		* Gasket, Oil fill
25A	35499		"O" Ring
26	33069		Dipstick (Incl. 25A)
28	32426		Spacer, Governor rod
29	650588		Screw, 1/4-20 x 2"
30	31927		Oil Drain Plug
31	31968		Link, Governor
32	650451		Screw, 1/4-20 x 1"
33	31964		Clamp, Governor lever
34	29193		Ring, Retaining
35	31963		Lever, Governor adjusting

Ref #	Part Number	Qty	Description
36	650518		Lockwasher
37	650544		Screw, 10-24 x 7/8"
38	7975		Nut, 10-24
39	31965		Plate, Governor spring
40	30312		Screw, 10-32 x 1/2"
41	31967		Spring, Governor
42	30590A		Washer, Flat
43	32425		Rod Assy., Governor
44	31948		Spool, Governor
45	29193		Ring, Retaining
46	31947		Gear Assy., Governor
47	31930		Shaft, Mechanical Governor
48	32000A		* Gasket, Cylinder head
49	33034		Head, Cylinder
51	650694A		Screw, 5/16-18 x 2" (Use as required)
51	650711		Screw, 5/16-18 x 1-5/8" (Use as required)
51	650628A		Screw, 5/16-18 x 2-3/8" (Use as required)
51	650695A		Screw, 5/16-18 x 2-1/4" (Use as required)
51	650714		Screw, 5/16-18 x 1-5/8" (Use as required)
51	650697A		Screw, 5/16-18 x 2-1/2" (Use as required)
51	650692		Screw, 5/16-18 x 1-3/4" (Use as required)
51	650603		Screw, 5/16-18 x 5/8" (Use as required)
53	33636		Resistor Spark Plug (RJ-8C)
53	34251		Resistor Spark Plug (RJ-17LM)
54	33035		Cover, Cylinder head
55	28537		Washer, Plain
57	650691		Washer, Flat (Use as required)
58	650690		Washer, Belleville (Use as required)
58	8274		Washer, Lock (Use as required)
59	650128		Screw, 10-24 x 1/2"
60	31976		Extension, Blower housing
61	31978		Bracket, Fuel tank
63	410144B		Fuel Cap (White Plastic)(Std.)(As required)
63	34210		Fuel Cap (Red Plastic) (Spurt resistant, High profile) (Use as required)
64	31979		Strap, Fuel tank
65	650451		Screw, 1/4-20 x 1"
66	650456		Nut, Flange whiz-lock, 1/4-20
67	650517		Screw, 1/4-20 x 27/32" (Use as required)
67	650561		Screw, 1/4-20 x 5/8" (Use as required)
67	30063		Screw, 1/4-20 x 1/2" (Use as required)
67	792028		Screw, 5/16-18 x 7/8" (Use as required)
70B	29683		Strainer & Shut-off, Fuel
71	26460		Clamp, Fuel line (Use as required)
72	29774		Fuel Line (Braided) (8.25") (Use as required)
72	30705		Fuel Line (Braided) (16") (Use as required)
72	30962		Fuel Line (Braided) (32") (Use as required)
72	30965		Fuel Line (Braided) (48") (Use as required)
73	31975		Baffle, Blower housing
74	650561		Screw, 1/4-20 x 5/8"
75	33356		Terminal
76	28545		Grommet, Plastic
77	650760		Screw, 8-32 x 3/8"
78	31932		Bearing, Tapered roller
79	31928		Cup, Bearing

Ref #	Part Number	Qty	Description
80	32031		Spacer, Steel (.010" thick) NOTE: Determine the gap between the cover and the machined surface on the cylinder which can be from .001"up to .007" in which case no shim gaskets will be required. Use of gasket must be limited to a combined total of .010" thick. Steel spacersmust be used as required
81	31971		* Gasket, Shim (.004/.005 thick) NOTE: Determine the gap between the cover and the machined surface on the cylinder which can be from .001"up to .007" in which case no shim gaskets will be required. Use of gasket must be limited to a combined total of .010" thick. Steel spacersmust be used as req
82A	32599		"O" Ring
82	31972		* Gasket, Shim (.005/.007 thick) NOTE: Determine the gap between the cover and the machined surface on the cylinder which can be from .001"up to .007" in which case no shim gaskets will be required. Use of gasket must be limited to a combined total of .010" thick. Steel spacersmust be used as req
83	32677		Cover, Cylinder NOTE: Determine the gap between the cover and the machined surface on the cylinder which can be from .001"up to .007" in which case no shim gaskets will be required. Use of gasket must be limited to a combined total of .010" thick. Steel spacersmust be used as required to eliminat
84A	650679		Lockwasher, 5/16" (Use as required)
84	650668		Screw, 10-32 x 1"
85	650666		Washer, Lock
86	650594		Nut, Flywheel, 3/4-16
87	33037		Blower Housing
91	8274		Washer, Lock
92	650595		Screw, 5/16-24 x 3/8"
93	32039		Switch, Stop
94	650890		Washer, Shakeproof
95	26073		Washer, Flat
96	650624		Screw, 5/16-24 x 9/16"
98	31958		* Gasket, Breather
99	31957		Breather Assy.
100	35350		Tube, Breather
101	650128		Screw, 10-24 x 1/2"
102	28558		Washer, Wave
103	31966		Bushing, Control lever
104	31984A		Lever, Control
105	650597		Screw, 10-24 x 5/8"
106	650591		Screw, 10-24 x 2"
107	33099		Spring
109	32043B		Muffler
112	33038		Plug, Button (Use as required)
113	29752		Nut & Lockwasher Assy.
114	650587		Stud, Carburetor
115	27272		* Gasket, Air cleaner
120	650399		Screw, 10-32 x 5/8"
121	30767		Spacer, Air cleaner

Ref #	Part Number	Qty	Description
122D	32378		Bracket, Air cleaner
122E	32376		Bracket, Air cleaner
125A	32009		Cover, Air cleaner
126	650513		Nut, Wing
128	650713		Screw, 5/16-18 x 5/8" (Use as require d)
128	650429		Screw, 5/16-18 x 3/4" (Use as require d)
128	792028		Screw, 5/16-18 x 7/8" (Use as require d)
141A	8274		Lockwasher, Split (Use as required)
141	26073		Washer, Flat (Use as required)
145	31960		* Gasket, Carburetor
147	31959		Baffle, Air
156	730201		Trigger Pin Kit (Use as required)
173	610118		Cover, Spark plug (Use as required)
176	31992		Spacer, Screen
177	8345		Washer, 1/4 plain (Use as required)
178	27070		Washer, Lock 1/4 E.T. (Use as require d)
178	650675		Washer, Flat 1/4 (Use as required)
184	27793		Clip, Conduit
185	28942		Screw, 10-32 x 3/8"
187	650713		Screw, 5/16-18 x 5/8"
188	26073		Washer, Flat
246	33776		Screen, Starter pulley
247	31980		Pulley, Starter
248	650680		Screw, 1/4-20 x 1-1/2"
249	32046		Rope Assy., Starter (Use as required)
266	610750		Grommet, Lead wire
278	610758		Flywheel
299B	550223		Decal, Name
299B	32676		Decal, Solid State
299A	31752		Decal, Air cleaner
299	34346		Decal, Instruction
300	32255A		Valve, Seat, Spring & Gasket Assy.
301	631564		Carburetor (Incl. 145) (Refer to Division 5, Section A, page 94 for breakdown)
304	33237A		* Gasket Set (Incl. items marked *)

This illustration may not depict actual equipment and is for reference only!

VIEW 2 of 3

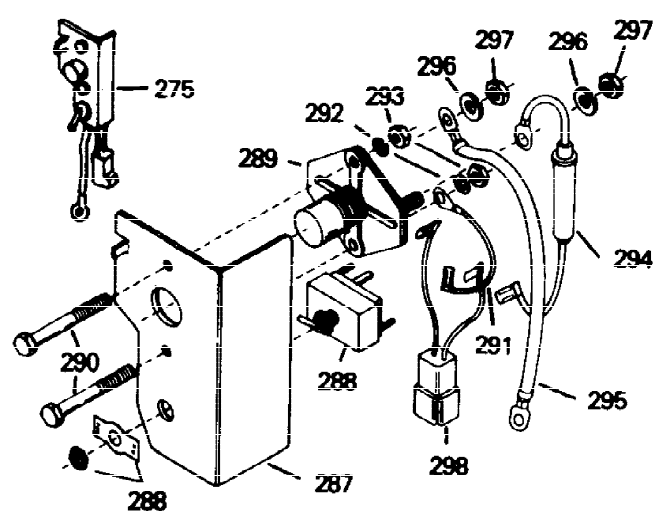
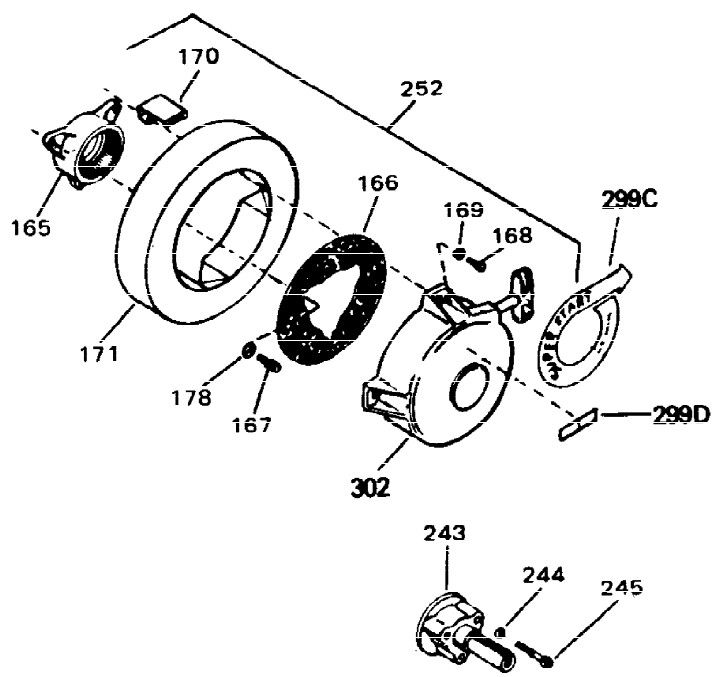
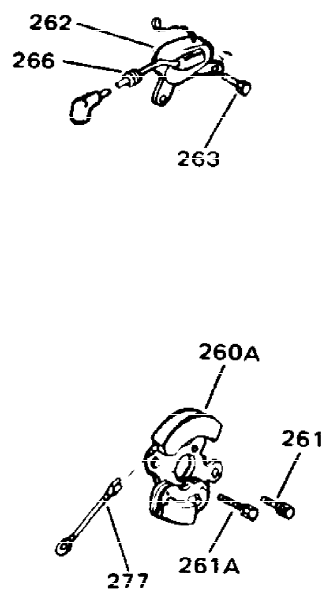
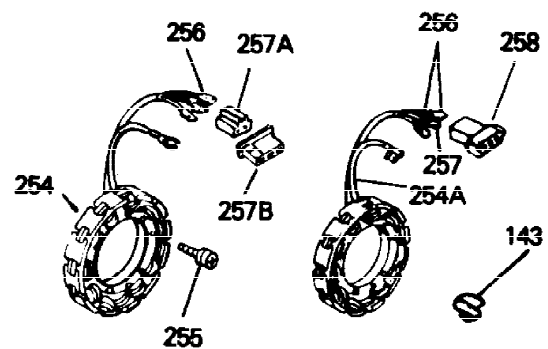
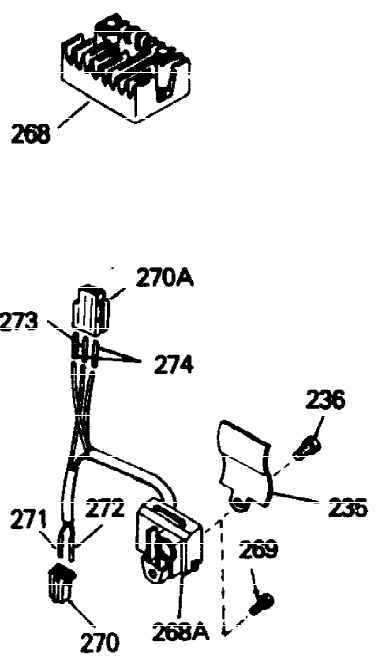
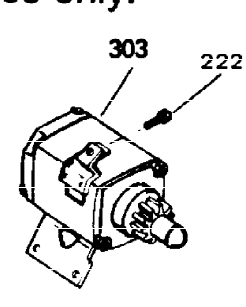
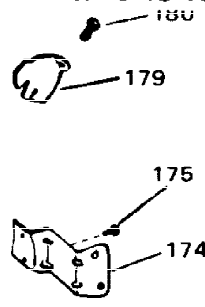
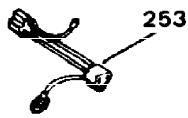

Ref #	Part Number	Qty	Description
178	27070		Washer, Lock 1/4 E.T. (Use as require d)
178	650675		Washer, Flat 1/4 (Use as required)
180	650701		Screw, 8-18 x 7/16" (Use as required)
222	792028		Screw, 5/16-18 x 7/8" (Use w/32817 st r.motor)
222	650781		Screw,5/16-18 x 11/16"(Use w/33835 st r.motor)
235	34276		Plate, Cover (Use as required to cover regulator mounting hole in blower housing)
236	650736		Screw, 10-16 x 3/8" (Use as required)
252	730134		Rewind Starter Kit (Incl. 165, 166, 167, 168, 169 & 291) (Use as required)
253	33018		Harness Assy., Adapter (Use as requir ed)
257B	610824		Flat Connector (Female terminals) (As req.)
260A	610759		Solid State Magneto
261	650489		Screw, 1/4-20 x 5/8"
261A	650669		Screw, 5/16-18 x 1-1/4"
262	610760		Solid State Transformer Ass'y.(Incl.1 73,266)
263	650561		Screw, 1/4-20 x 5/8"
266	610750		Grommet, Lead wire
275	730198		Starter Switch Kit(Incl. 287-298) (As req.)
277	30831		Ground Wire (Incl. 75)

ILLUSTRATION SHOWS TYPICAL PARTS ONLY. ORDER BY PART NUMBER. PARTS NOT LISTED ARE SUPPLIED BY OEM.



Ref #	Part Number	Qty	Description
41	31967		Spring, Governor
62A	31977		Fuel Tank (Incl. 63)
70	29634		Fitting, Fuel line
71	26460		Clamp, Fuel line (Use as required)
72	29774		Fuel Line (Braided) (8.25") (Use as required)
72	30705		Fuel Line (Braided) (16") (Use as required)
72	30962		Fuel Line (Braided) (32") (Use as required)
72	30965		Fuel Line (Braided) (48") (Use as required)
110A	32585		55 Degree Exhaust Elbow
111	650590		Nut, Conduit
119	28534		Pipe Plug, 1/8-27 (Use as required)
119	9556		Plug, Pipe, 1/8-27 (Use as required)
123A	32008		Element, Air cleaner
184	27793		Clip, Conduit
185	28942		Screw, 10-32 x 3/8"