

718-0241B
225-3010L

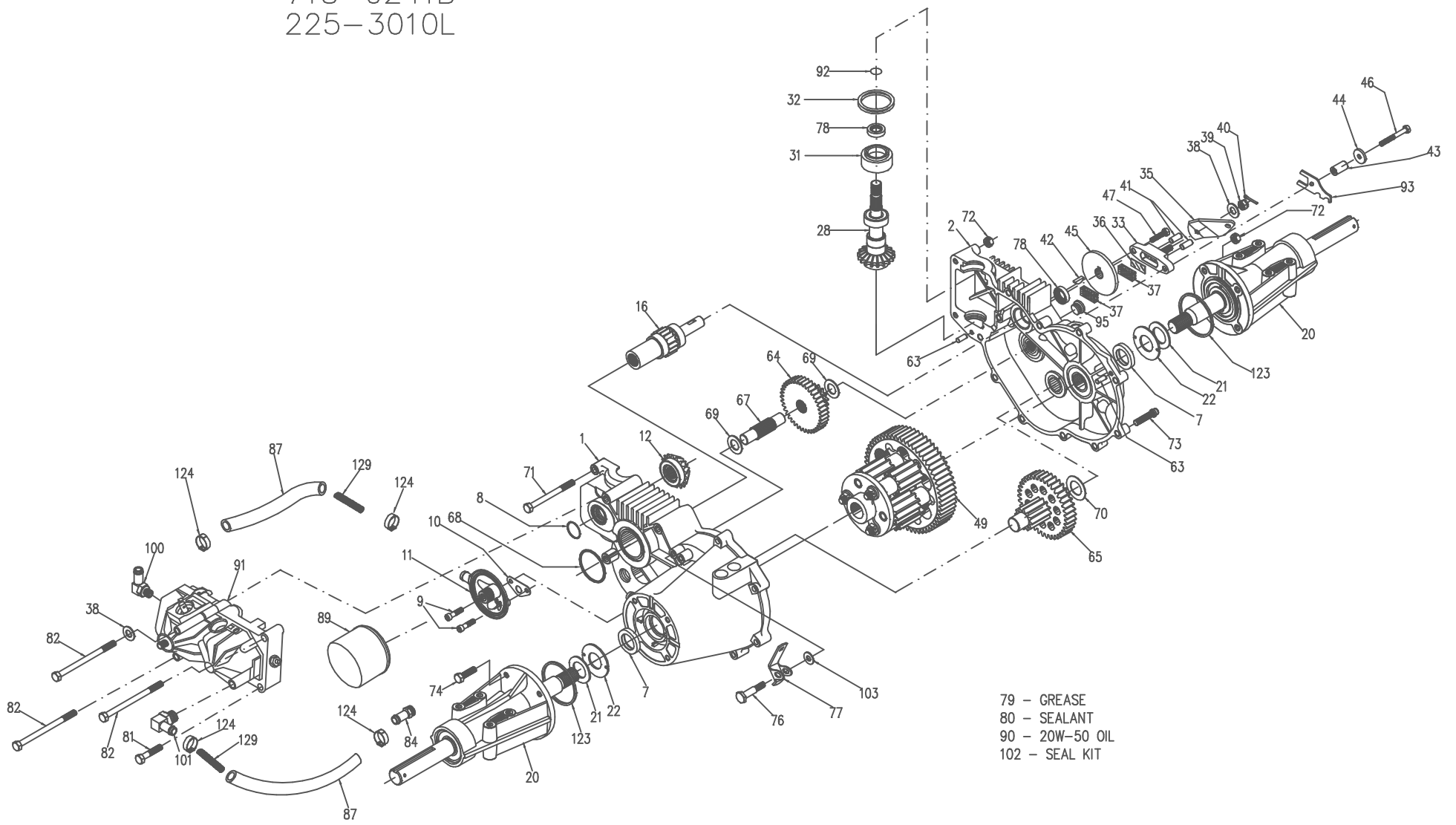

718-0241B
225-3010L

ITEM NO.	HYDRO-GEAR PART NO.	QTY	DESCRIPTION	ITEM NO.	HYDRO-GEAR PART NO.	QTY	DESCRIPTION
1	70361	1	ASSEMBLY, L H HOUSING	37	44132	2	PUCK, BRAKE
		1	L H HOUSING	38	44130	2	WASHER, 7/8OD X 7/16 X .060 HT
		1	DISC, THRUST 1-1/8 OD	39	44142	1	NUT, SLOTTED HEX
		1	BEARING, NEEDLE SCE1412	40	44101	1	PIN, COTTER
		1	BEARING, BALL 25MM X 52MM	41	44127	2	PIN, BRAKE ACTUATING
		1	BEARING, NEEDLE - SCH 1012	42	44143	1	KEY, HI-PRO 3/16 X 5/8
		1	SEAL, OIL .984 X 1.5 X .25	43	23711	1	SPACER
		2	CAP SCREW, 1/4-20 X 1.0	45	44090	1	DISC, BRAKE
		1	GASKET, FILTER BASE	46	44300	1	BOLT, 1/4-20 X 2
		1	BASE, OIL FILTER	47	44433	1	BOLT, 1/4-20 X 1 W/NYLOK GR5
2	70364	1	ASSEMBLY, R H HOUSING	49	70251	1	DIFFERENTIAL ASSEMBLY
		1	HOUSING, R H TRANSAXLE			2	GEAR, 12T DIFFERENTIAL
		1	BOLT, RIB NECK 5/16-18			6	GEAR, 10T PLANET DIFFERENTIAL
		1	WASHER, RUBBER 5/8 OD X .313 ID X .04			6	SPACER, DIFFERENTIAL
		1	BEARING, NEEDLE SCE1412			3	SPACER, SHAFT
		1	BEARING, BALL 25MM X 52MM			1	DIFFERENTIAL END CAP
		1	BEARING, NEEDLE - SCH 1012			3	BOLT, 3/8-24 X 4.5 GD8
		1	SEAL, OIL .984 X 1.5 X .25			3	NUT, HEX LOCK 3/8-24 GD8
7	44782	2	OIL SEAL, .984 X 1.5 X .25			1	SHAFT, DIFFERENTIAL
8	50070	1	QUAD RING			1	GEAR, 60T DIFFERENTIAL
10	44920	1	GASKET, FILTER BASE				
11	70210	1	ASSY, FILTER BASE	63	44757	2	PIN, DOWEL
		2	CAP SCREW, 1/4-20 X 1	64	44776	1	GEAR, REDUCTION 14T-38T
		1	GASKET, FILTER BASE	65	70051	1	FINAL DRIVE PINION ASSEMBLY
		1	BASE, OIL FILTER			1	GEAR 38T
12	62876	1	PINION ASSEMBLY			1	GEAR 12T
		1	BEARING BALL, 25MM X 42MM X 9MM	67	44779	1	SHAFT, JACK
		1	PINION, 18T DRIVEN	68	44781	1	O-RING
16	62877	1	BRAKE SHAFT ASSEMBLY	69	44795	2	WASHER, FL 5/8ID X 1-1/4 X .05
		1	SHAFT, BRAKE	70	44794	1	WASHER, FL 7/8ID X 1-1/2OD HT
		2	BEARING, BALL .62 X 1.38 X .43	71	44827	2	BOLT, HEX HD 5/16-18 X 3-1/2
		1	GEAR, 17T	72	43083	4	HEX NUT 5/16-18
		1	COUPLING	73	50868	11	TORX HEAD SCREW, 5/16-18
20	62888	2	AXLE MOUNTING HORN ASSEMBLY	74	45089	7	CAP SCREW, HEX 5/16-18 X 1 GR5
		1	AXLE MOUNTING HORN				
		1	BEARING, 25MM ID (W/ SEALS)	76	44785	1	BOLT, SHOULDER
		1	WASHER, 1.0 X 1.63 X .08 HT	77	44786	1	ARM, FREEWHEEL ACTUATING
		1	WASHER, 1.0 X 2.06 X .09 HT	78	44761	2	SEAL, OIL .625 X 1.0 X .25
		1	SHAFT, AXLE	79	50416	1	GREASE (10 OZ. TUBE)
		1	RING, RETAINING	80	50928	1	SEALANT
21	44805	2	WASHER, 1.0 X 1.63 X .08 HT	81	43084	1	BOLT, HEX 5/16-18 X 1-3/4 GR 5
22	44806	2	WASHER, 1.0 X 2.06 X .09 HT	82	44820	3	BOLT, 5/16-18 X 4-1/2 GR 5
28	70054	1	ASSY, INPUT	84	50591	1	1/2" BEADED 9/16 STAIGHT FITTING
		1	BEARING, BALL .62 X 1.38 X .43	87	50594	2	1/2" HOSE, 8-3/4" LONG
		1	BEARING, BALL 15MM X 35MM X 11MM	89	50037	1	SPIN-ON FILTER
		1	PINION, INPUT 18T	90		99.8oz	20W-50 OIL
		1	SHAFT, INPUT	91	BDU-10L-258	1	BDU-10L-258
		2	BUSHING, THRUST	92	2003016	1	RING, WIRE RETAINING
		1	RETAINING RING	93	17434A	1	MTD BRACKET
31	50925	1	WIRE RETAINING RING	95	9005110-5600	1	PLUG, STRAIGHT THREAD
32	50945	1	BEARING, RETAINER	100	50589	1	1/2" BEADED 90° 9/16 FITTING
33	62589	1	QUAD RING	101	50592	1	1/2" BEADED 90° 7/8 FITTING
		1	BRAKE YOKE ASSEMBLY	102	70052	1	SEAL KIT
		1	YOKE, BRAKE	103	50169	1	WASHER
35	44094	1	BOLT, SQ HD 5/16-24	123	50405	2	O RING
36	44134	1	ARM, BRAKE	124	50590	4	PINCH CLAMP
		1	PLATE, PUCK	129	50666	2	SPRING, SHORT